













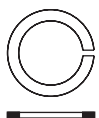

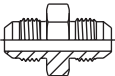
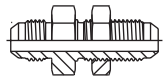
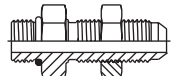
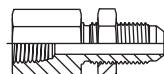



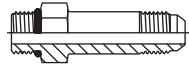
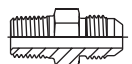

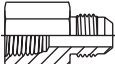

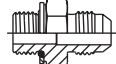

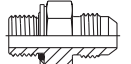
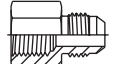





Triple-Lok® 37° Flare Tube Fittings and Adapters



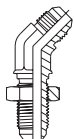
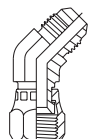
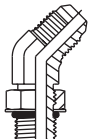
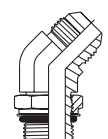
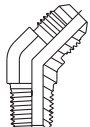
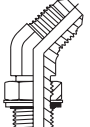
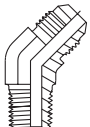
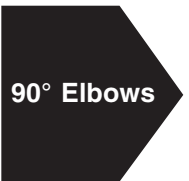
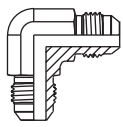

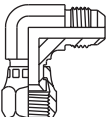
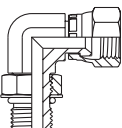
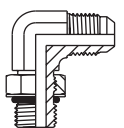
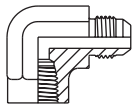
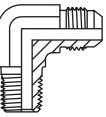
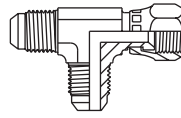
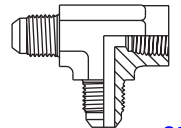
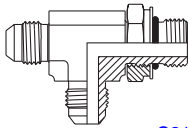
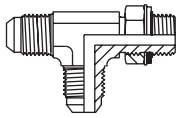
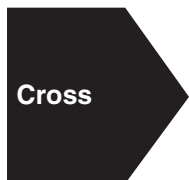
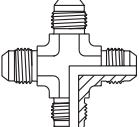
The Fitting Authority





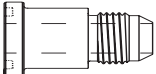
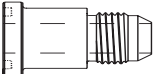
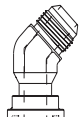

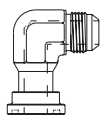
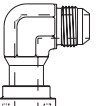

	BTX Nut  C9	TX and TX Metric Sleeve  C9	WLN Bulkhead Locknut  C10	SBR Braze Ring  C10	
		HTX Union  C10	LHTX Large Hex Union  C10	WTX Bulkhead Union  C11	WF50X SAE-ORB / 37° Bulkhead  C11
WGTX NPTF / 37° Bulkhead  C12		TRTX / TRTXN Reducer  C13	XHX6 Extender and Expander  C12	F50X SAE-ORB / 37° Flare  C14	FF50X SAE-ORB / 37° – Long  C14
FTX NPTF / 37° Flare  C15	FFTX NPTF / 37° Flare – Long  C15	GTX NPTF / 37° Flare  C15	F870MX ISO 6149 / 37° Flare  C16	F82EDMX Metric-ED / 37° Flare  C16	F80MX Metric-ORR / 37° Flare  C16
F42EDMX BSPP-ED / 37° Flare  C16	F40MX BSPP-ORR / 37° Flare  C17	G4MX BSPP / 37° Flare  C17	F3MX BSPT / 37° Flare  C17		HX6 37° Swivel Union  C17
F650X SAE-ORB / 37° Swivel  C18	F6X NPTF / 37° Swivel  C18	G6X NPTF / 37° Swivel  C18	F6870MX ISO-6149 / 37° Swivel  C18		F682EDMX Metric-ED / 37° Swivel  C19
F63MX BSPT / 37° Swivel  C19		WNTX Bulkhead Union  C20	V6X 37° Swivel Elbow  C20	V50X SAE-ORB / 37° Flare  C20	V870MX ISO-6149 / 37° Flare  C20
VTX NPTF / 37° Flare  C21		V40MX BSPP-ORR / 37° Flare  C21	V3MX BSPT / 37° Flare  C21		ETX Union Elbow  C21

C6X 37° Swivel Elbow  C22	AOEX6 SAE-ORB / 37° Swivel  C22	X6EF NPTF / 37° Swivel  C23	C50X SAE-ORB / 37° Flare  C23	CC50X SAE-ORB / 37° – Long  C23	CTX NPTF / 37° Flare  C24
CCTX NPTF / 37° Flare – Long  C24	CCCTX NPTF / 37° – Extra Long  C24	DTX NPTF / 37° Flare  C25	C870MX ISO-6149 / 37° Flare  C25	C80MX Metric-ORR / 37° Flare  C25	C40MX BSPP-ORR / 37° Flare  C26
C3MX BSPT / 37° Flare  C26	Tees 	JTX Union Tee  C26	WJTX Bulkhead Branch Tee  C27	WJJTX Bulkhead Run Tee  C27	JX6 37° Swivel Union Tee  C28
S6X 37° Swivel Branch Tee  C28	R6X 37° Swivel Run Tee  C28	S50X SAE-ORB Branch Tee  C29	R50X SAE-ORB Run Tee  C29	STX NPTF Branch Tee  C30	RTX NPTF Run Tee  C30
OTX NPTF Branch Tee  C30	MTX NPTF Run Tee  C30	S870MX ISO 6149 Branch Tee  C31	R870MX ISO 6149 Run Tee  C31	S40MX BSPP-ORR Branch Tee  C31	R40MX BSPP-ORR Run Tee  C31
Cross 	KTX Union Cross  C32	Plug and Cap 	PNTX 37° Plug  C32	FNTX 37° Cap  C32	T22X Mountie Cap  C32

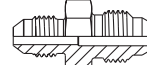

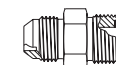
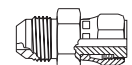
Flange Adapters (Shown in Section M)

SAE Flange Adapters 	XHQ1 Code 61 / 37° Flare  M9	XHQ2 Code 62 / 37° Flare  M9	XVQ1 Code 61 / 37° Flare  M27	XVQ2 Code 62 / 37° Flare  M27	XEQ1 Code 61 / 37° Flare  M28
XEQ2 Code 62 / 37° Flare  M28					

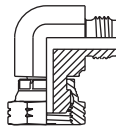



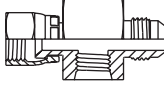

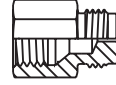

Conversion Adapters (Shown in Sections K and L)

	XHU86 Metric Swivel (EO) / 37°  L5	XHMKA Komatsu 30° / 37° Flare  K5	XHMKA6 Komatsu 30° Swivel / 37°  K5	XHLO 37° Flare / ORFS  L3	XHL6 37° Flare / ORFS Swivel  L3
	LOHX6 ORFS / 37° Swivel  L3	XHBU 37° Flare / Flareless  L4	XHMK46 37° Flare / BSPP Swivel  L5	XEMK46 37° Flare / BSPP Swivel  L5	

Diagnostic and Orifice Fittings (Shown in Section N)

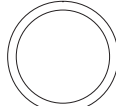
	XHX6G5TP 37° Flare / 37° Swivel / SAE-ORB  N5		XHX7 37° Flare / 37° Female with Orifice  N11

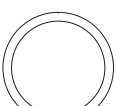
O-Rings and Seals (Shown in Section O)

	SAE O-Ring  O3	ISO 6149 O-Ring  O4	Metric O-Ring  O4	Metric Retaining Ring  O4	BSPP O-Ring  O5
	BSPP Retaining Ring  O5	Eoelastic Seal Ring  O5			

Introduction

Parker pioneered the flare fitting concept early in the early 20th century. The design has since gained worldwide acceptance due to its many inherent features and customer benefits. Today, the 37° flare fitting is the most widely used fitting in the world. Its appeal is in its simplicity, compact design, ease of assembly, reliability (single seal), material availability, adaptability to inch or metric tube, worldwide availability and acceptance. Further helping its acceptance is its widespread use as a hose adapter. As a tube fitting, it is especially suited for thin and medium wall thickness tube. Even though 37° flare fittings are generally considered to be 3000 psi fittings, Triple-Lok's capabilities range from 9000 psi for 1/4" size to 2000 psi for 2" size. Currently, it is used in virtually every application that uses fluid power for motion control.

Parker's Triple-Lok fittings meet the strict requirements of SAE J514 and ISO 8434-2 industry standards. Additionally, they meet many customer and industry-recognized conformance standards and type approvals.

Design and Construction

The Triple-Lok (37° flare fitting) design is simple. It uses an easily produced flare at the tube end to seal and hold fluid under high pressure. The fitting consists of three pieces: the body, sleeve and nut. The tube end is flared at a 37° angle (74° included angle) and held between the fitting nose (seat) and the sleeve (support) with the nut as shown in Fig. C2, providing a very effective (single) seal between the fitting nose and the tube flare.

The design of Triple-Lok fittings is very efficient. The fitting incorporates the smallest seal area of all fitting types. This seal area, as seen in Fig. C2, is only slightly larger than the fluid flow area. The small seal area results in a compact design, low assembly torque, and a relatively high-pressure capability.

The primary difference between a two-piece flare fitting and the three-piece design is the flare support sleeve. The support sleeve provides several key functions:

1. It provides a clamping surface for the tube flare.
2. It provides a bearing surface for the tube nut. The sleeve isolates the tube from the nut, minimizing the tube twist during assembly, a common problem of 2-piece flare fitting designs.
3. It provides support to the tube flare. The tapered fitting nose tends to "wedge open" the tube flare during assembly. The sleeve helps to resist this expansion, thus eliminating the possibility of tube flare and sleeve jamming inside the nut. This eliminates any waste of applied torque and allows for easy disassembly.
4. It makes the fitting adaptable to metric tube merely by changing its inside diameter (see Table C2).

Due to the popularity and simplicity of the 37° flare fitting, many manufacturers offer the product. Even though most manufacturers conform to the same dimensional standards, there are significant performance advantages with Parker's Triple-Lok fittings due to Parker's optimized manufacturing methods and commitment to quality.

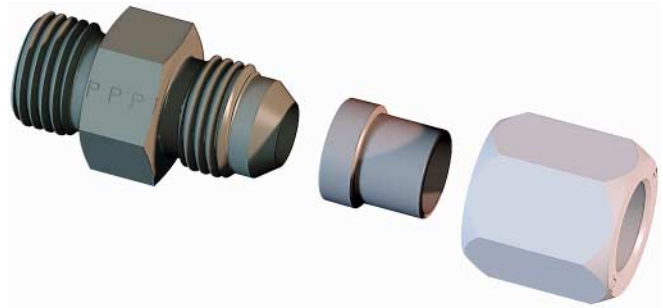

Fig. C1 – Triple-Lok Fitting Body, Sleeve and Nut

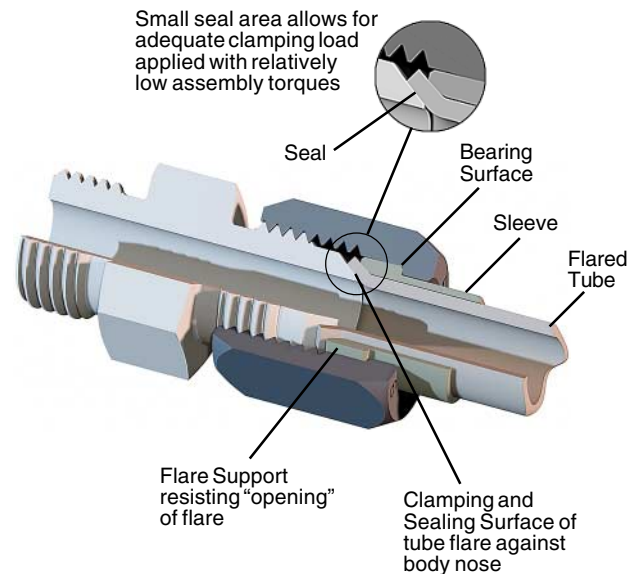

Fig. C2 – Triple-Lok Design and Features

Materials and Manufacture

Triple-Lok fitting components are manufactured using state-of-the-art equipment and manufacturing technologies to assure construction integrity, optimum strength and toughness, long service life and the highest quality. At the heart of the Triple-Lok product line are the finest raw materials and manufacturing technologies as outlined in [Table C1](#) and discussed below.

The Triple-Lok Body: Triple-Lok fittings are manufactured in over 65 configurations. Straight bodies are either cold formed or machined from cold drawn bar stock. The cold forming process ensures consistent dimensional tolerances, improved mechanical properties and better surface finishes. Shaped Triple-Lok fittings are manufactured from a one-piece forged construction. This forged construction eliminates the potential leak path associated with multi-component brazed fittings. Triple-Lok steel forged shapes also feature an optimum combination of hardness and toughness for high-pressure capability, minimal nose collapse (typical of sizes -10 and under) during repeated assembly and long service life, even under severe operating conditions.

The Triple-Lok Sleeves: Most steel Triple-Lok flare support sleeves are cold formed and heat treated for an optimum combination of strength and ductility. The largest size sleeves, -20, -24, and -32, are machined from high strength steel. Stainless steel and brass sleeves are machined from cold drawn barstock.

The Triple-Lok Tube Nuts: Triple-Lok steel tube nuts are cold formed, except in sizes -20, -24, and -32, which are machined from cold drawn barstock. Cold forming increases the material strength and its fatigue properties, imparting high strength and longer service life to the nuts. Smaller stainless steel nuts are also cold formed while all brass tube nuts are manufactured from cold drawn brass barstock. Most crimp swivel nuts are also cold formed.

How Triple-Lok Fittings Work

Tightening of the nut clamps the tube flare between the body nose (seat) producing a leak tight connection. This clamping on the 37° taper provides a measure of elasticity to the joint helping it to resist loosening under vibration. The clamping force results in a small radial load that tends to deform the fitting nose radially. The resistance of the nose to elastic deformation provides a constant preload (similar to a lockwasher) keeping it tight.

The clamping force provided by the nut resists the opposing force of the fluid under pressure. The joint remains leak tight as long as the clamping force is higher than the opposing pressure load. Properly assembled Triple-Lok fittings with appropriate tube will seal consistently under pressure until tube bursts.

Sealing in Triple-Lok fittings takes place between two smooth metal surfaces, the fitting nose and inside of the tube flare. Therefore, the sealing surfaces have to be smooth, free of any nicks, scratches, spiral tool marks, splits or weld beads. Seamless or welded and drawn fully annealed tube is recommended for Triple-Lok fittings for ease in flaring and bending. Certain types of harder tubes that are not fully annealed may not be suitable for flaring due to the potential for immediate or long-term cracking of the tube flare. For specific tube type and wall thickness recommendations, please see [Table C3](#).

Triple-Lok Fittings	Steel		Stainless Steel		Brass	
	ASTM	Type	ASTM	Type	ASTM	Type
Cold Formed Bodies	A576	C1010/ C1008	—	—	—	—
Forged Bodies	A576	1214/ 1215	A182	316	B124	CA377
Bar Stock Bodies	A108	12L14	A479	316	B16 B453	CA360 CA345
Cold Formed Nuts	A576	C1010/ C1008	A276	316	B121	CA335
Bar Stock Tube Nuts	A108	12L14	A479	316	B16 B453	CA360 CA345
Cold Formed Sleeves	SAE 1020	SAE 1020	—	—	B111	CA443 CA444
Bar Stock Sleeves	A108	C1137	A479	316	B371	CA694

Table C1 – Standard Material Specifications for Triple-Lok Fittings

Note: On request, Triple-Lok fittings can be furnished in materials other than those shown above.

Finish: Zinc with yellow chromate is used on all standard steel products. Stainless steel fittings are passivated.

International Acceptance

The Triple-Lok male flare end is attachable to either inch tube, metric tube or a hose assembly. Parker offers many different port thread options for the various international hydraulic ports available. This is one of the primary reasons for its worldwide acceptance. Parker has traditionally offered a "Metric Triple-Lok" product line directed at the Metric, ISO-6149 and BSPP port users. Rather than carrying a separate catalog section, this range of international fittings has been integrated into the traditional "Triple-Lok" section.

To illustrate the versatility of Triple-Lok, refer to Fig. C3. A single 37° fitting body will accept both inch and metric tube sizes by simply changing the sleeve. Thus, a dedicated line of sleeves is offered for inch and metric tube. The universal tube nut and fitting body is used with either inch or metric tube, thus saving on component costs and making the Triple-Lok fitting more versatile. Also, the 37° body without the nut and sleeve is very popular as a hose adapter.

Study the following example illustrating the options with an SAE -8 (1/2") Triple-Lok fitting:

1. Fitting with a -8 (1/2") sleeve and -8 (1/2") tube nut can connect to a 1/2" o.d. flared tube.
2. Fitting with a 12 mm sleeve and -8 (1/2") tube nut can connect to 12 mm o.d. flared tube
3. Fitting without a nut and sleeve can be used as a 1/2" hose adapter when connected to a hose swivel.

Table C2 illustrates an even clearer picture of the flexibility of the Triple-Lok 37° system. It shows every "convertible sleeve" connection for the 37° flare design. For example, if 25 mm tube is being used, a -16 (1") 37° flare fitting together with a 25 mm (TXS25) sleeve and a standard -16 (1") flare fitting nut would be all the necessary components to connect and seal a 25 mm flared tube assembly.

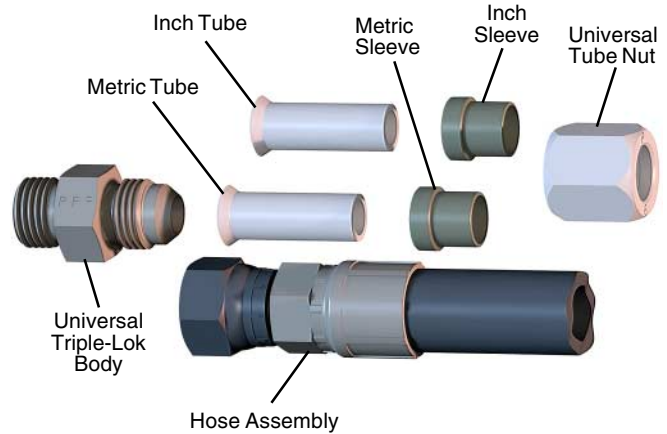

Fig. C3 – Triple-Lok's Adaptability to Inch Tube, Metric Tube, or Hose Assemblies

FITTING DASH SIZE	TUBE O.D.	METRIC TUBE SLEEVE PART #	NUT PART #
-4	6mm	TXS6	4 BTX-S
-5	8mm	5 TX-S	5 BTX-S
-6	10mm	TXS10	6 BTX-S
-8	12mm	TXS12	8 BTX-S
-10	14mm	TXS14	10 BTX-S
-10	15mm	TXS15	10 BTX-S
-10	16mm	10 TX-S	10 BTX-S
-12	18mm	TXS18	12 BTX-S
-12	20mm	20-12 TX-S	20-12 BTX-S
-14	22mm	TXS22	14 BTX-S
-16	25mm	TXS25	16 BTX-S
-20	28mm	TXS28	20 BTX-S
-20	30mm	TXS30	20 BTX-S
-20	32mm	TXS32	20 BTX-S
-24	35mm	TXS35	24 BTX-S
-24	38mm	24 TX-S	24 BTX-S

Table C2 – Triple-Lok Convertible Sleeve Connections

Tube Wall Thickness – Inch and Metric

Minimum/Maximum tube wall thickness is based on the pressure holding capacity of the fittings and subject to maximum wall thickness limitations.

FITTING DASH SIZE	WALL THICKNESS – INCH TUBE			WALL THICKNESS – METRIC TUBE		
	O.D. (in.)	Min. (in.)	Max.	O.D. (mm)	Min. (mm)	Max.
-2	1/8	0.010	– 0.035	–	–	–
-3	3/16	0.010	– 0.035	–	–	–
-4	1/4	0.020	– 0.065	6.0	0.5	– 2.0
-5	5/16	0.020	– 0.065	8.0	0.5	– 2.0
-6	3/8	0.020	– 0.065	10.0	0.5	– 2.0
-8	1/2	0.028	– 0.083	12.0	1.0	– 2.0
-10	5/8	0.035	– 0.095	14.0	1.0	– 2.5
-10	5/8	0.035	– 0.095	15.0	1.0	– 2.5
-10	5/8	0.035	– 0.095	16.0	1.0	– 2.5
-12	3/4	0.035	– 0.109	18.0	1.0	– 3.0
-12	3/4	0.035	– 0.109	20.0	1.0	– 3.0
-14	7/8	0.035	– 0.109	22.0	1.0	– 3.0
-16	1	0.035	– 0.120	25.0	1.0	– 3.0
-20	1 1/4	0.049	– 0.120	30.0	1.5	– 3.0
-20	1 1/4	0.049	– 0.120	32.0	1.5	– 3.0
-24	1 1/2	0.049	– 0.120	38.0	1.5	– 3.0
-32	2	0.058	– 0.134	50.0	1.5	– 3.5

Table C3 – Wall Thickness Chart for Inch and Metric Tubing

Features, Advantages & Benefits

Feature	Advantage	Benefit
Small sealing area	Low assembly torque to achieve sealing.	Ease of assembly.
Metal-to-metal seal	Allows for wide range of operating temperatures and media.	Versatility for different applications.
No minimum wall thickness limitation	Allows for optimum tube selection and lower weight hydraulic package.	Reduces material cost and weight.
Short tube entry	Minimum tube prying required for installation and maintenance.	Easier installation and maintenance.
Adaptable to metric tube	Easily meets customer's needs for inch or metric tube.	Versatility for end customer and for customer standardization efforts.
International standard design	Meets global needs.	Standardization. Global acceptance.
Worldwide availability	Due to the proven design, worldwide customer acceptance, adaptability to metric and inch tube as well as hose adapter, Triple-Lok fittings are readily available throughout the world.	OEM and aftermarket support and parts readily available worldwide.
Used as hose adapter	Adapts directly to hose swivel connection, the most commonly used hose connection in the world. One connector for tube and hose.	Versatility for flexible system requirements. Minimizes connector proliferation.
Available in steel, stainless steel and brass	Wide selection.	Optimum match to customer's needs.
Forged shapes	No potential leak path and longer fatigue life.	Long service life.
	Compact design.	Used in tighter spaces without redesigning.
Heat treated forgings	Optimum balance of strength and toughness. Minimum nose collapse. Balanced strength and shock resistance.	Flow restrictions are minimal, repeated assembly possible, no leakage. Higher working pressure and longer service life.
Cold formed tube nuts and sleeves	Stronger than machined nuts.	Longer service life. More robust product.
Widest range of tube O.D. sizes available in a hydraulic fitting	All standard and several non-traditional sizes are available including: 1/8", 3/16", 5/16", 7/8", 2" and 2-1/2" tube O.D. sizes. Also, 16 different metric tube sizes are adaptable to Triple-Lok.	Additional flexibility for hydraulic systems.
Broad line of configurations and port ends available	Meets global needs for OEM and MRO applications.	Standardization and cost control. Less components. Eliminates conversion adapters.

Table C4 – Features, Advantages and Benefits

BTX

Nut
37° Flare

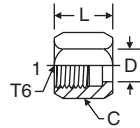

SAE 070110
HPD Base # 06B

TUBE FITTING PART #	END SIZE 1		T6 UN/UNF-2B	C HEX (in.)	D (in.)	L (in.)	STANDARD FROM STOCK		
	(in.)	(mm)					-S	-SS	-B
2 BTX	1/8	—	5/16-24	3/8	0.18	0.55	•	•	•
3 BTX	3/16	—	3/8-24	7/16	0.24	0.61	•	•	•
4 BTX	1/4	6	7/16-20	9/16	0.31	0.62	•	•	•
5 BTX	5/16	8	1/2-20	5/8	0.38	0.68	•	•	•
6 BTX	3/8	10	9/16-18	11/16	0.44	0.73	•	•	•
8 BTX	1/2	12	3/4-16	7/8	0.57	0.85	•	•	•
10 BTX	5/8	14, 15, 16	7/8-14	1	0.70	0.98	•	•	•
12 BTX	3/4	18	1 1/16-12	1 1/4	0.84	1.03	•	•	•
20-12 BTX	—	20	1 1/16-12	32.0mm	21.2mm	26.0mm	•	•	•
14 BTX	7/8	—	1 3/16-12	1 3/8	0.96	1.09	•	•	•
16 BTX	1	25	1 5/16-12	1 1/2	1.09	1.13	•	•	•
20 BTX	1 1/4	28, 30, 32	1 5/8-12	2	1.35	1.23	•	•	•
24 BTX	1 1/2	35, 38	1 7/8-12	2 1/4	1.62	1.42	•	•	•
32 BTX	2	42, 50	2 1/2-12	2 7/8	2.17	1.75	•	•	•

-
-
-
-
-

TX (inch)

Sleeve
37° Flare

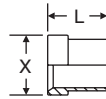

HPD Base # 06S

TUBE FITTING PART #	TUBE O.D. (in.)	L (in.)	X (in.)	STANDARD FROM STOCK		
				-S	-SS	-B
2 TX	1/8	0.34	0.27	•	•	•
3 TX	3/16	0.34	0.33	•	•	•
4 TX	1/4	0.41	0.38	•	•	•
5 TX	5/16	0.44	0.45	•	•	•
6 TX	3/8	0.50	0.50	•	•	•
8 TX	1/2	0.56	0.68	•	•	•
10 TX	5/8	0.66	0.80	•	•	•
12 TX	3/4	0.69	0.97	•	•	•
14 TX	7/8	0.75	1.10	•	•	•
16 TX	1	0.78	1.22	•	•	•
20 TX	1 1/4	0.91	1.53	•	•	•
24 TX	1 1/2	1.13	1.78	•	•	•
32 TX	2	1.19	2.41	•	•	•

TX (metric)

Sleeve
37° Flare

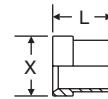

TUBE FITTING PART #	SEE NOTE	TUBE O.D. (mm)	FITTING DASH SIZE	L (mm)	X (mm)	STANDARD FROM STOCK		
						-S	-SS	-B
TXS6	3	6	-4	10.4	9.6	•		
5 TX	1	8	-5	11.2	11.4	•		
TXS8	3	8	-5	11.2	11.3	•		
TXS10	3	10	-6	12.7	12.7	•		
TXS12	3	12	-8	14.2	17.3	•	•	
TXS14		14	-10	16.8	20.3	•		
TXS15		15	-10	16.8	20.3	•		
10 TX	1	16	-10	16.8	20.3	•		
TXS18	3	18	-12	17.3	24.6	•		
20-12 TX	2	20	-12	17.3	24.6	•		
TXS22		22	-14	19.0	27.8	•		
TXS25		25	-16	19.8	31.0	•		
TXS28		28	-20	23.1	38.9	•		
TXS30		30	-20	23.1	38.9	•		
TXS32		32	-20	23.1	38.9	•		
TXS35		35	-24	28.4	45.2	•		
24 TX	1	38	-24	28.4	45.2	•		

1. Inch sleeve for use with metric tubing.
2. Use with 20-12 BTX.
3. The part numbers above are for steel. Use "SS" in place of "S" for ordering stainless steel. Example: TXSS12



WLN

Bulkhead Locknut

SAE 080118 and 070118
HPD Base # 53-XN

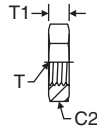

TUBE FITTING PART #	TUBE O.D. (in.)	C2 HEX (in.)	T1 (in.)	STANDARD FROM STOCK		
				-S	-SS	-B
3 WLN	3/16	5/8	0.22	•	•	•
4 WLN	1/4	11/16	0.28	•	•	•
5 WLN	5/16	3/4	0.28	•	•	•
6 WLN	3/8	13/16	0.27	•	•	•
8 WLN	1/2	1	0.31	•	•	•
10 WLN	5/8	1 1/8	0.36	•	•	•
12 WLN	3/4	1 3/8	0.41	•	•	•
14 WLN	7/8	1 1/2	0.41	•	•	•
16 WLN	1	1 5/8	0.41	•	•	•
20 WLN	1 1/4	1 7/8	0.41	•	•	•
24 WLN	1 1/2	2 1/8	0.41	•	•	•
32 WLN	2	2 3/4	0.41	•	•	•

SBR

Braze Ring
(For use with XHB3)

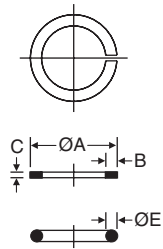

TUBE FITTING PART #	TUBE O.D. (in.)	A DIA. (in.)	B (in.)	C (in.)	E (in.)	STANDARD FROM STOCK		
						-S	-SS	-B
4SBR	1/4	0.260			0.05	•	•	
6SBR	3/8	0.390	0.07	0.03		•	•	
8SBR	1/2	0.515	0.07	0.03		•	•	
10SBR	5/8	0.640	0.07	0.03		•	•	
12SBR	3/4	0.765	0.08	0.04		•	•	
14SBR	7/8	0.890			0.06	•	•	
16SBR	1	1.015	0.08	0.04		•	•	
20SBR	1 1/4	1.265	0.08	0.04		•	•	
24SBR	1 1/2	1.515	0.08	0.04		•	•	
32SBR	2	2.015			0.09	•	•	

HTX

Full Dimensions

Union
37° Flare / 37° Flare

SAE 070101
HPD Base # 0303

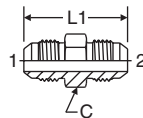

TUBE FITTING PART #	END SIZE		C HEX (in.)	L1 (in.)	STANDARD Dynamic Pressure (x 1,000 PSI)		
	1 (in.)	2 (in.)			-S	-SS	-B
2 HTX	1/8	1/8	7/16	1.17	7.5	9.0	3.3
3 HTX	3/16	3/16	7/16	1.23	7.5	9.0	3.3
4 HTX	1/4	1/4	1/2	1.38	7.5	9.0	3.3
4-2 HTX	1/4	1/8	1/2	1.27		9.0	
4-3 HTX	1/4	3/16	1/2	1.30		9.0	
5 HTX	5/16	5/16	9/16	1.38	6.0	7.2	3.3
5-4 HTX	5/16	1/4	9/16	1.38		7.2	
6 HTX	3/8	3/8	5/8	1.41	6.0	7.2	3.3
6-4 HTX	3/8	1/4	5/8	1.41	6.0	7.2	
6-5 HTX	3/8	5/16	5/8	1.41		7.2	
8 HTX	1/2	1/2	13/16	1.62	6.0	7.2	3.3
8-4 HTX	1/2	1/4	13/16	1.52	6.0	7.2	
8-6 HTX	1/2	3/8	13/16	1.52	6.0	7.2	
10 HTX	5/8	5/8	15/16	1.88	5.0	6.0	3.3
10-8 HTX	5/8	1/2	15/16	1.78	5.0	6.0	
12 HTX	3/4	3/4	1 1/8	2.16	5.0	6.0	3.3
12-8 HTX	3/4	1/2	1 1/8	1.95	5.0	6.0	
12-10 HTX	3/4	5/8	1 1/8	2.05	5.0	6.0	
14 HTX	7/8	7/8	1 1/4	2.22	5.0	6.0	2.6
16 HTX	1	1	1 3/8	2.25	4.0	4.8	2.6
16-12 HTX	1	3/4	1 3/8	2.20	4.0	4.8	
20 HTX	1 1/4	1 1/4	1 11/16	2.44	4.0	4.8	
24 HTX	1 1/2	1 1/2	2	2.75	3.0	3.6	
24-10 HTX	1 1/2	5/8	2	2.42		3.6	
24-12 HTX	1 1/2	3/4	2	2.53		3.6	
24-16 HTX	1 1/2	1	2	2.58		3.6	
32 HTX	2	2	2 5/8	3.41	2.0	2.4	
32-24 HTX	2	1 1/2	2 5/8	2.81		2.4	

LHTX

Full Dimensions

Large Hex Union
37° Flare / 37° Flare

SAE 070119
HPD Base # 03L3

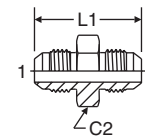

TUBE FITTING PART #	END SIZE		C2 HEX (in.)	L1 (in.)	STANDARD Dynamic Pressure (x 1,000 PSI)		
	1 TO 2 (in.)				-S	-SS	-B
4 LHTX	1/4		11/16	1.38	7.5	9.0	3.3
4-3 LHTX	1/4 to 3/16		11/16	1.30		9.0	
5 LHTX	5/16		3/4	1.38	6.0		
6 LHTX	3/8		13/16	1.41	6.0	7.2	3.3
6-4 LHTX	3/8 to 1/4		13/16	1.41		7.2	
8 LHTX	1/2		1	1.62	6.0	7.2	3.3
8-4 LHTX	1/2 to 1/4		1	1.52		7.2	
8-6 LHTX	1/2 to 3/8		1	1.52		7.2	
10 LHTX	5/8		1 1/8	1.88	5.0	6.0	
12 LHTX	3/4		1 3/8	2.16	5.0	6.0	
12-8 LHTX	3/4 to 1/2		1 3/8	1.95		6.0	
16 LHTX	1		1 5/8	2.25	4.0	4.8	
32 LHTX	2		2 3/4	3.41		2.4	



WTX Full Dimensions

Bulkhead Union
37° Flare / 37° Flare

SAE 070601
HPD Base # 0353
WTX-WLN – Body with locknut
(See page C10 for WLN)

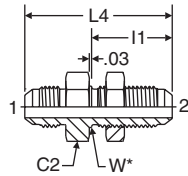

W* – Bulkhead pilot dia.
recommended clearance
hole +.015 over W dia.

TUBE FITTING PART #	END SIZE		C2 HEX (in.)	I1 (in.)	L4 (in.)	W DIA. (in.)	MAX. BULKHEAD WALL THICKNESS (in.)	STANDARD Dynamic Pressure (x 1,000 PSI)		
	1 & 2 (in.)	UN/UNF-2A						-S	-SS	-B
3 WTX	3/16	5/8	1.11	1.91	0.38	0.38	7.5			
4 WTX	1/4	11/16	1.20	2.08	0.44	0.33	7.5	9.0	3.3	
5 WTX	5/16	3/4	1.20	2.08	0.50	0.33	6.0		3.3	
6 WTX	3/8	13/16	1.28	2.19	0.56	0.42	6.0	7.2	3.3	
8 WTX	1/2	1	1.44	2.44	0.75	0.44	6.0	7.2	3.3	
10 WTX	5/8	1 1/8	1.58	2.75	0.88	0.43	5.0	6.0	3.3	
12 WTX	3/4	1 3/8	1.75	3.09	1.06	0.44	5.0	6.0	3.3	
14 WTX	7/8	1 1/2	1.75	3.13	1.19	0.41	5.0			
16 WTX	1	1 5/8	1.75	3.14	1.31	0.39	4.0	4.8		
20 WTX	1 1/4	1 7/8	1.80	3.31	1.63	0.40	4.0	4.8		
24 WTX	1 1/2	2 1/8	1.81	3.52	1.88	0.28	3.0	3.6		
32 WTX	2	2 3/4	2.09	4.20	2.50	0.28	2.0	2.4		

WF50X Full Dimensions

ORB Bulkhead Connector
37° Flare / ORB

HPD Base # 0355
WF50X-WLN – Body with locknut
(See page C10 for WLN)

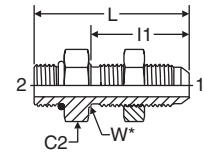

W* – Bulkhead pilot dia.
recommended clearance
hole +.015 over W dia.

TUBE FITTING PART #	END SIZE		C2 HEX (in.)	I1 (in.)	L (in.)	STANDARD Dynamic Pressure (x 1,000 PSI)		
	1 (in.)	2 UN/UNF-2A				-S	-SS	-B
4 WF50X	1/4	7/16-20	11/16	1.20	1.84	7.5		
6 WF50X	3/8	9/16-18	13/16	1.28	2.02	6.0		
8 WF50X	1/2	3/4-16	1	1.44	2.19	6.0		
10 WF50X	5/8	7/8-14	1 1/8	1.58	2.47	5.0		
12 WF50X	3/4	1 1/16-12	1 3/8	1.75	2.79	5.0		
16 WF50X	1	1 5/16-12	1 5/8	1.75	2.90	4.5		

WFTX Full Dimensions

Male Bulkhead Connector
37° Flare / NPTF

HPD Base # 0153
WFTX-WLN – Body with locknut
(See page C10 for WLN)

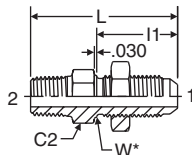

W* – Bulkhead pilot dia.
recommended clearance
hole +.015 over W dia.

TUBE FITTING PART #	END SIZE		C2 HEX (in.)	I1 (in.)	L (in.)	W DIA. (in.)	MAX. BULKHEAD WALL THICKNESS (in.)	STANDARD Dynamic Pressure (x 1,000 PSI)		
	1 (in.)	2 NPTF						-S	-SS	-B
4 WFTX	1/4	1/8-27	11/16	1.20	1.88	0.44	0.33	6.0	6.0	
4-4 WFTX	1/4	1/4-18	11/16	1.20	2.07	0.44	0.33	6.0	6.0	
6 WFTX	3/8	1/4-18	13/16	1.28	2.15	0.56	0.42	6.0	6.0	
6-6 WFTX	3/8	3/8-18	3/4	1.28	2.16	0.56	0.42	6.0	6.0	
6-8 WFTX	3/8	1/2-14	7/8	1.28	2.41	0.56	0.42	6.0	6.0	
8 WFTX	1/2	3/8-18	1	1.44	2.31	0.75	0.44	6.0	6.0	
8-8 WFTX	1/2	1/2-14	1	1.44	2.56	0.75	0.44	6.0	6.0	
10 WFTX	5/8	1/2-14	1 1/8	1.58	2.71	0.88	0.43	5.0		
12 WFTX	3/4	3/4-14	1 3/8	1.75	2.95	1.06	0.44	5.0	5.0	
16 WFTX	1	1-11 1/2	1 5/8	1.75	3.14	1.31	0.39	4.5	4.5	

How to Order

Specs

Assembly / Installation

3-D CAD Model

Reference

WGTX Full Dimensions

Female Bulkhead Connector
37° Flare / NPTF

HPD Base # 0253
WGTX-WLN – Body with locknut
(See page C10 for WLN)

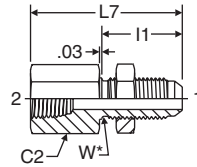

W* – Bulkhead pilot dia.
recommended clearance
hole +.015 over W dia.

TUBE FITTING PART #	END SIZE		C2 HEX (in.)	I 1 (in.)	L7 (in.)	W DIA. (in.)	MAX. BULKHEAD WALL THICKNESS (in.)	STANDARD Dynamic Pressure (x 1,000 PSI)		
	1 (in.)	2 NPTF						-S	-SS	-B
4 WGTX	1/4	1/8-27	11/16	1.20	1.84	0.44	0.33	6.0	6.0	
4-4 WGTX	1/4	1/4-18	3/4	1.33	2.11	0.44	0.33	6.0	6.0	
6 WGTX	3/8	1/4-18	13/16	1.28	2.06	0.56	0.42	6.0	6.0	
6-6 WGTX	3/8	3/8-18	7/8	1.28	2.24	0.56	0.42	6.0	6.0	
8 WGTX	1/2	3/8-18	1	1.44	2.34	0.75	0.44	6.0	6.0	
8-8 WGTX	1/2	1/2-14	1 1/8	1.44	2.61	0.75	0.44	5.0	5.0	
10 WGTX	5/8	1/2-14	1 1/8	1.58	2.66	0.88	0.43	5.0	5.0	
12 WGTX	3/4	3/4-14	1 3/8	1.75	2.91	1.06	0.44	4.0	4.0	
14 WGTX	7/8	3/4-14	1 1/2	1.75	2.89	1.19	0.41	4.0		
16 WGTX	1	1-11 1/2	1 5/8	1.75	3.09	1.31	0.39	3.0		
24 WGTX	1 1/2	1 1/2-11 1/2	2 1/4	1.81	3.35	1.88	0.28	2.0	2.0	

XHX6 Full Dimensions

Extender and Expander
37° Flare / 37° Flare Swivel

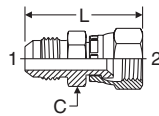

TUBE FITTING PART #	END SIZE		C HEX (in.)	L (in.)	STANDARD Dynamic Pressure (x 1,000 PSI)		
	1 (in.)	2 (in.)			-S	-SS	-B
4 XHX6	1/4	1/4	9/16	1.39	7.5		
6 XHX6	3/8	3/8	5/8	1.50	5.0		
6-4 XHX6	3/8	1/4	5/8	1.50	5.0		
8 XHX6	1/2	1/2	13/16	1.71	5.0		
8-6 XHX6	1/2	3/8	13/16	1.72	5.0		
10 XHX6	5/8	5/8	1	2.01	5.0		
10-8 XHX6	5/8	1/2	15/16	1.93	5.0		
12 XHX6	3/4	3/4	1 1/4	2.27	5.0		
12-10 XHX6	3/4	5/8	1 1/8	2.20	5.0		
16 XHX6	1	1	1 1/2	2.47	3.6		
16-12 XHX6	1	3/4	1 1/2	2.31	3.6		
20-16 XHX6	1 1/4	1	1 11/16	2.50	3.6		



TRTX / TRTXN Full Dimensions

Reducer
37° Flare

SAE 070123 / SAE 070123A
HPD Base # 0603 (TRTXN only)

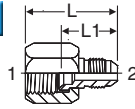

TRTXN
2-piece
(Nut and Insert)

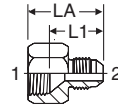

TRTXN
1-piece
(Non-swivel)

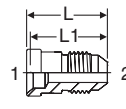

TRTX
(Insert only)

TUBE FITTING PART #			END SIZE		L (TRTX)	LA (TRTXN)	L1 (TRTXN / TRTX)	STANDARD Dynamic Pressure (x 1,000 PSI)		
TRTXN 2-pc. Design (Insert with Large Nut)	TRTXN 1-pc. Design (Machined Female)	TRTX Reducer Insert (For 2-pc. Design Only)	1 (in.)	2 (in.)				-S	-SS	-B
4-2 TRTXN	-	4-2 TRTX	1/4	1/8				0.75	1.14	0.69
-	4-3 TRTXN	-	1/4	3/16	-	1.09	0.66		9.0	
-	5-4 TRTXN	-	5/16	1/4	-	1.16	0.71	6.0	7.2	
6-4 TRTXN	-	6-4 TRTX	3/8	1/4	0.97	1.40	0.90	6.0	7.2	3.3
-	6-5 TRTXN	-	3/8	3/16	-	1.19	0.73	6.0	7.2	
8-4 TRTXN	-	8-4 TRTX	1/2	1/4	1.00	1.50	0.91	6.0	7.2	3.3
8-6 TRTXN	-	8-6 TRTX	1/2	3/8	1.00	1.50	0.91	6.0	7.2	3.3
10-4 TRTXN	-	10-4 TRTX	5/8	1/4	1.03	1.61	0.95	5.0	6.0	
10-6 TRTXN	-	10-6 TRTX	5/8	3/8	1.03	1.61	0.95	5.0	6.0	3.3
-	10-8 TRTXN	-	5/8	1/2	-	1.48	0.89	5.0	6.0	
12-4 TRTXN	-	12-4 TRTXN	3/4	1/4	1.09	1.69	0.98	5.0	6.0	3.3
12-6 TRTXN	-	12-6 TRTXN	3/4	3/8	1.09	1.69	0.98	5.0	6.0	3.3
12-8 TRTXN	-	12-8 TRTXN	3/4	1/2	1.19	1.79	1.08	5.0	6.0	3.3
-	12-10 TRTXN	-	3/4	5/8	-	1.66	1.02	5.0	6.0	
14-6 TRTXN	-	14-6 TRTX	7/8	3/8	1.13	1.77	1.01	5.0		
14-10 TRTXN	-	14-10 TRTX	7/8	5/8	1.33	1.98	1.22	5.0		
-	14-12 TRTXN	-	7/8	3/4	-	1.84	1.15	5.0		
16-4 TRTXN	-	16-4 TRTX	1	1/4	1.22	1.90	1.06		4.8	
16-6 TRTXN	-	16-6 TRTX	1	3/8	1.22	1.90	1.06		4.8	
16-8 TRTXN	-	16-8 TRTX	1	1/2	1.27	1.95	1.15	4.0	4.8	
16-10 TRTXN	-	16-10 TRTX	1	5/8	1.38	2.06	1.20	4.0		
16-12 TRTXN	-	16-12 TRTX	1	3/4	1.47	2.15	1.36	4.0	4.8	
-	16-14 TRTXN	-	1	8/7	-	1.91	1.20	4.0		
20-12 TRTXN	-	20-12 TRTX	1 1/4	3/4	1.53	2.23	1.37	4.0	4.8	
20-16 TRTXN	-	20-16 TRTX	1 1/4	1	1.59	2.30	1.44	4.0	4.8	
24-8 TRTXN	-	24-8 TRTX	1 1/2	1/2	1.56	2.39	1.31		3.6	
24-12 TRTXN	-	24-12 TRTX	1 1/2	3/4	1.63	2.46	1.43		3.6	
24-16 TRTXN	-	24-16 TRTX	1 1/2	1	1.63	2.46	1.43	3.0	3.6	
24-20 TRTXN	-	24-20 TRTX	1 1/2	1 1/4	1.69	2.52	1.47	3.0		
32-24 TRTXN	-	32-24 TRTX	2	1 1/2	1.91	2.96	1.64	2.0	2.4	



F50X Full Dimensions

Straight Thread Connector
37° Flare / SAE-ORB

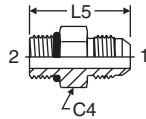

SAE 070120
HPD Base # 0503

TUBE FITTING PART #	END SIZE		C4 HEX (in.)	L5 (in.)	STANDARD Dynamic Pressure (x 1,000 PSI)		
	1 (in.)	2 UN/UNF-2A			-S	-SS	-B
2 F50X	1/8	5/16-24	7/16	1.06	7.5	9.0	
3 F50X	3/16	3/8-24	1/2	1.10	7.5	9.0	
3-2 F50X	3/16	5/16-24	1/2	1.10		9.0	
4 F50X	1/4	7/16-20	9/16	1.23	7.5	9.0	
4-3 F50X	1/4	3/8-24	9/16	1.19		9.0	
4-5 F50X	1/4	1/2-20	5/8	1.23	6.0	7.2	
4-6 F50X	1/4	9/16-18	11/16	1.28	6.0	7.2	
4-8 F50X	1/4	3/4-16	7/8	1.38	6.0	7.2	
4-10 F50X	1/4	7/8-14	1	1.49	5.0		
5 F50X	5/16	1/2-20	5/8	1.23	6.0	7.2	
5-4 F50X	5/16	7/16-20	9/16	1.23	6.0		
5-6 F50X	5/16	9/16-18	11/16	1.30	6.0		
5-8 F50X	5/16	3/4-16	7/8	1.37	6.0		
6 F50X	3/8	9/16-18	11/16	1.30	6.0	7.2	
6-4 F50X	3/8	7/16-20	5/8	1.27	6.0	7.2	
6-5 F50X	3/8	1/2-20	5/8	1.27	6.0		
6-8 F50X	3/8	3/4-16	7/8	1.38	6.0	7.2	
6-10 F50X	3/8	7/8-14	1	1.50	5.0	6.0	
6-12 F50X	3/8	1 1/16-12	1 1/4	1.66	5.0	6.0	
8 F50X	1/2	3/4-16	7/8	1.48	6.0	7.2	
8-4 F50X	1/2	7/16-20	13/16	1.50	6.0	7.2	
8-6 F50X	1/2	9/16-18	13/16	1.44	6.0	7.2	
8-10 F50X	1/2	7/8-14	1	1.59	5.0	6.0	
8-12 F50X	1/2	1 1/16-12	1 1/4	1.77	5.0	6.0	
8-16 F50X	1/2	1 5/16-12	1 1/2	1.78	4.5	5.4	
10 F50X	5/8	7/8-14	1	1.70	5.0	6.0	
10-6 F50X	5/8	9/16-18	11/16	1.71	5.0	6.0	
10-8 F50X	5/8	3/4-16	15/16	1.64	5.0	6.0	
10-12 F50X	5/8	1 1/16-12	1 1/4	1.86	5.0	6.0	
10-16 F50X	5/8	1 5/16-12	1 1/2	1.89	4.5	5.4	
12 F50X	3/4	1 1/16-12	1 1/4	1.97	5.0	6.0	
12-8 F50X	3/4	3/4-16	1 1/8	1.94	5.0	6.0	
12-10 F50X	3/4	7/8-14	1 1/8	1.88	5.0	6.0	
12-14 F50X	3/4	1 3/16-12	1 3/8	1.96	5.0		
12-16 F50X	3/4	1 5/16-12	1 1/2	1.99	4.5	5.4	
12-20 F50X	3/4	1 5/8-12	1 7/8	2.08	4.0		
14 F50X	7/8	1 3/16-12	1 3/8	1.99	5.0		
14-16 F50X	7/8	1 5/16-12	1 1/2	2.02	4.5		
16 F50X	1	1 5/16-12	1 1/2	2.05	4.5	5.4	
16-8 F50X	1	3/4-16	1 3/8	1.78	4.5	5.4	
16-10 F50X	1	7/8-14	1 3/8	2.08	4.5	5.4	
16-12 F50X	1	1 1/16-12	1 3/8	1.99	4.5	5.4	
16-14 F50X	1	1 3/16-12	1 3/8	2.05	4.5		
16-20 F50X	1	1 5/8-12	1 7/8	2.13	4.0	4.8	
16-24 F50X	1	1 7/8-12	2 1/8	2.20	3.0		
20 F50X	1 1/4	1 5/8-12	1 7/8	2.17	4.0	4.8	
20-12 F50X	1 1/4	1 1/16-12	1 11/16	2.30	4.0	4.8	
20-16 F50X	1 1/4	1 5/16-12	1 11/16	2.33	4.0	4.8	
20-24 F50X	1 1/4	1 7/8-12	2 1/8	2.24	3.0	3.6	
24 F50X	1 1/2	1 7/8-12	2 1/8	2.38	3.0	3.6	
24-20 F50X	1 1/2	1 5/8-12	2	2.53	3.0	3.6	
24-32 F50X	1 1/2	2 1/2-12	2 3/4	2.53	2.0		
32 F50X	2	2 1/2-12	2 3/4	2.78	2.0	2.4	
32-24 F50X	2	1 7/8-12	2 5/8	2.94	2.0		

FF50X Full Dimensions

Long Straight Thread Connector
37° Flare / SAE-ORB

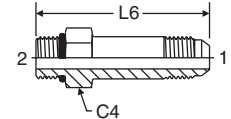

SAE 071720
HPD Base # 053E

TUBE FITTING PART #	END SIZE		C4 HEX (in.)	L6 (in.)	STANDARD Dynamic Pressure (x 1,000 PSI)		
	1 (in.)	2 UN/UNF-2A			-S	-SS	-B
4 FF50X	1/4	7/16-20	9/16	2.08	7.5	9.0	
4-6 FF50X	1/4	9/16-18	11/16	2.13		7.2	
6 FF50X	3/8	9/16-18	11/16	2.31	6.0	7.2	
8 FF50X	1/2	3/4-16	7/8	2.70	6.0	7.2	
10 FF50X	5/8	7/8-14	1	3.03	5.0	6.0	
12 FF50X	3/4	1 1/16-12	1 1/4	3.61	5.0	6.0	
16 FF50X	1	1 5/16-12	1 1/2	3.98	4.5	5.4	
20 FF50X	1 1/4	1 5/8-12	1 7/8	4.69	4.0		

XHB3 Full Dimensions

Braze Socket
37° Flare / Inch Tube Braze

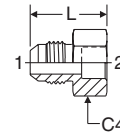

TUBE FITTING PART #	END SIZE		C4 HEX (in.)	L (in.)	STANDARD Dynamic Pressure (x 1,000 PSI)		
	1 (in.)	2 (in.)			-S	-SS	-B
4 XHB3	1/4	1/4	9/16	0.97	7.5		
6 XHB3	3/8	3/8	5/8	1.00	6.0		
6-4 XHB3	3/8	1/4	5/8	1.00	6.0		
6-8 XHB3	3/8	1/2	5/8	1.00	6.0		
8 XHB3	1/2	1/2	13/16	1.12	6.0		
8-10 XHB3	1/2	5/8	13/16	1.12	5.0		
10 XHB3	5/8	5/8	15/16	1.21	5.0		
10-8 XHB3	5/8	1/2	15/16	1.21	5.0		
10-12 XHB3	5/8	3/4	1 1/8	1.37	5.0		
12 XHB3	3/4	3/4	1 1/4	1.51	5.0		
12-10 XHB3	3/4	5/8	1 1/8	1.51	5.0		
12-16 XHB3	3/4	1	1 1/4	1.57	4.0		
16 XHB3	1	1	1 3/8	1.63	4.0		
16-20 XHB3	1	1 1/4	1 11/16	1.73	4.0		
20 XHB3	1 1/4	1 1/4	1 11/16	1.71	4.0		
20-24XHB3	1 1/4	1 1/2	2	1.71	3.0		
24 XHB3	1 1/2	1 1/2	2	1.84	3.0		
32 XHB3	2	2	2 5/8	2.16	2.0		

Note: Braze rings are on page C10.

- How to Order
- Specs
- Assembly / Installation
- 3-D CAD Model
- Reference

FTX Full Dimensions

Male Connector
37° Flare / NPTF

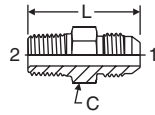

SAE 070102
HPD Base # 0103

TUBE FITTING PART #	END SIZE		C HEX (in.)	L (in.)	STANDARD Dynamic Pressure (x 1,000 PSI)		
	1 (in.)	2 NPTF			-S	-SS	-B
	2 FTX	1/8			1/8-27	7/16	1.11
3 FTX	3/16	1/8-27	7/16	1.14	6.0	6.0	3.3
4 FTX	1/4	1/8-27	1/2	1.22	6.0	6.0	3.3
4-4 FTX	1/4	1/4-18	9/16	1.42	6.0	6.0	3.3
4-6 FTX	1/4	3/8-18	3/4	1.44	6.0	6.0	
4-8 FTX	1/4	1/2-14	7/8	1.69	6.0	6.0	3.3
5 FTX	5/16	1/8-27	9/16	1.22	6.0	6.0	3.3
5-4 FTX	5/16	1/4-18	9/16	1.42	6.0	6.0	3.3
5-6 FTX	5/16	3/8-18	3/4	1.44	6.0	6.0	
6 FTX	3/8	1/4-18	5/8	1.43	6.0	6.0	3.3
6-2 FTX	3/8	1/8-27	5/8	1.24	6.0	6.0	3.3
6-6 FTX	3/8	3/8-18	3/4	1.44	6.0	6.0	3.3
6-8 FTX	3/8	1/2-14	7/8	1.69	6.0	6.0	3.3
6-12 FTX	3/8	3/4-14	1 1/8	1.75	5.5	5.5	
8 FTX	1/2	3/8-18	13/16	1.53	6.0	6.0	3.3
8-2 FTX	1/2	1/8-27	1 3/16	1.34	6.0	6.0	
8-4 FTX	1/2	1/4-18	13/16	1.53	6.0	6.0	3.3
8-8 FTX	1/2	1/2-14	7/8	1.78	6.0	6.0	3.3
8-12 FTX	1/2	3/4-14	1 1/8	1.85	5.5	5.5	2.6
8-16 FTX	1/2	1-11 1/2	1 3/8	2.05	4.5	4.5	
10 FTX	5/8	1/2-14	15/16	1.89	5.0	5.0	3.3
10-6 FTX	5/8	3/8-18	15/16	1.70	5.0	5.0	3.3
10-12 FTX	5/8	3/4-14	1 1/8	1.95	5.0	5.0	
12 FTX	3/4	3/4-14	1 1/8	2.06	5.0	5.0	2.6
12-6 FTX	3/4	3/8-18	1 1/8	1.88	5.0	5.0	
12-8 FTX	3/4	1/2-14	1 1/8	2.06	5.0	5.0	2.9
12-16 FTX	3/4	1-11 1/2	1 3/8	2.25	5.0	5.0	
12-20 FTX	3/4	1 1/4-11 1/2	1 11/16	2.36	5.0		
14 FTX	7/8	3/4-14	1 1/4	2.09	5.0	5.0	
16 FTX	1	1-11 1/2	1 3/8	2.30	4.5	4.5	2.0
16-8 FTX	1	1/2-14	1 3/8	2.11	4.5	4.5	
16-12 FTX	1	3/4-14	1 3/8	2.11	4.5	4.5	2.3
16-20 FTX	1	1 1/4-11 1/2	1 11/16	2.41	3.0	3.0	
16-24 FTX	1	1 1/2-11 1/2	2	2.50	3.0	3.0	
20 FTX	1 1/4	1 1/4-11 1/2	1 11/16	2.45	3.0	3.0	1.6
20-16 FTX	1 1/4	1-11 1/2	1 11/16	2.42	3.0		2.0
20-24 FTX	1 1/4	1 1/2-11 1/2	2	2.55	3.0	3.0	
24 FTX	1 1/2	1 1/2-11 1/2	2	2.67	3.0	3.0	1.3
24-16 FTX	1 1/2	1-11 1/2	2	2.62	3.0	3.0	
24-20 FTX	1 1/2	1 1/4-11 1/2	2	2.66	3.0		
24-32 FTX	1 1/2	2-11 1/2	2 5/8	2.86	2.0		
32 FTX	2	2-11 1/2	2 5/8	3.11	2.0	2.0	
32-24 FTX	2	1 1/2-11 1/2	2 5/8	3.08	2.0	2.0	
40 FTX	2 1/2	2 1/2-8	3 1/4	3.38	1.0		

FFTX Full Dimensions

Long Male Connector
37° Flare / NPTF

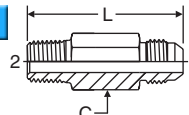

SAE 071802
HPD Base # 013E

TUBE FITTING PART #	END SIZE		C HEX (in.)	L (in.)	STANDARD Dynamic Pressure (x 1,000 PSI)		
	1 (in.)	2 NPTF			-S	-SS	-B
	4 FFTX	1/4			1/8-27	1/2	1.81
4-4 FFTX	1/4	1/4-18	9/16	2.25	6.0	6.0	
6 FFTX	3/8	1/4-18	5/8	2.25	6.0	6.0	
6-6 FFTX	3/8	3/8-18	3/4	2.50	6.0	6.0	
8 FFTX	1/2	3/8-18	13/16	2.75	6.0		
8-8 FFTX	1/2	1/2-14	15/16	2.80	6.0		
10 FFTX	5/8	1/2-14	15/16	3.12	5.0		
12 FFTX	3/4	3/4-14	1 1/8	3.50	5.0	5.0	

GTX Full Dimensions

Female Connector
37° Flare / NPTF

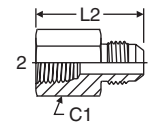

SAE 070103
HPD Base # 0203

TUBE FITTING PART #	END SIZE		C1 HEX (in.)	L2 (in.)	STANDARD Dynamic Pressure (x 1,000 PSI)		
	1 (in.)	2 NPTF			-S	-SS	-B
	2 GTX	1/8			1/8-27	9/16	1.12
3 GTX	3/16	1/8-27	9/16	1.13			3.3
4 GTX	1/4	1/8-27	9/16	1.19	6.0	6.0	3.3
4-4 GTX	1/4	1/4-18	3/4	1.39	6.0	6.0	3.3
4-6 GTX	1/4	3/8-18	7/8	1.45			6.0
4-8 GTX	1/4	1/2-14	1 1/8	1.68			6.0
5 GTX	5/16	1/8-27	9/16	1.17	6.0	6.0	3.3
5-4 GTX	5/16	1/4-18	3/4	1.39	6.0	6.0	3.3
6 GTX	3/8	1/4-18	3/4	1.41	6.0	6.0	3.3
6-2 GTX	3/8	1/8-27	5/8	1.19			6.0
6-6 GTX	3/8	3/8-18	7/8	1.46	6.0	6.0	3.3
6-8 GTX	3/8	1/2-14	1 1/8	1.69	5.0	5.0	
8 GTX	1/2	3/8-18	7/8	1.56	6.0	6.0	3.3
8-4 GTX	1/2	1/4-18	13/16	1.55	6.0	6.0	
8-8 GTX	1/2	1/2-14	1 1/8	1.79	5.0	5.0	3.3
8-12 GTX	1/2	3/4-14	1 3/8	1.85	4.0	4.0	
10 GTX	5/8	1/2-14	1 1/8	1.89	5.0	5.0	3.3
10-12 GTX	5/8	3/4-14	1 3/8	1.95	4.0	4.0	
12 GTX	3/4	3/4-14	1 3/8	2.06	4.0	4.0	2.6
12-8 GTX	3/4	1/2-14	1 1/8	2.05	5.0	5.0	
12-16 GTX	3/4	1-11 1/2	1 5/8	2.30	3.0	3.0	
14 GTX	7/8	3/4-14	1 3/8	2.06	4.0	4.0	
16 GTX	1	1-11 1/2	1 5/8	2.35	3.0	3.0	2.0
16-12 GTX	1	3/4-14	1 3/8	2.13	4.0	4.0	
16-20 GTX	1	1 1/4-11 1/2	2	2.44	2.5	2.5	
20 GTX	1 1/4	1 1/4-11 1/2	2	2.49	2.5	2.5	
20-16 GTX	1 1/4	1-11 1/2	1 3/4	2.47	3.0	3.0	
24 GTX	1 1/2	1 1/2-11 1/2	2 3/8	2.62	2.0	2.0	
32 GTX	2	2-11 1/2	2 7/8	2.97	1.5	1.5	



F87OMX Full Dimensions

Male Connector – ISO 6149
37° Flare / ISO 6149

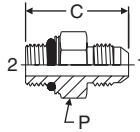

TUBE FITTING PART #	END SIZE		C (mm)	P (mm)	STANDARD Dynamic Pressure (x 1,000 PSI)		
	1 (mm)	2 Male Metric Parallel Thread			-S	-SS	-B
5M12F87OMX	8	M12x1.5	33.5	19	6.0		
6M14F87OMX	10	M14x1.5	33.5	19	6.0	6.0	
6M16F87OMX	10	M16x1.5	35.1	22	6.0		
8M16F87OMX	12	M16x1.5	37.6	22	6.0		
8M18F87OMX	12	M18x1.5	39.1	24	5.0	5.0	
10M18F87OMX	14, 15, 16	M18x1.5	41.7	24	5.0		
10M22F87OMX	14, 15, 16	M22x1.5	42.9	27	5.0	5.0	
12M22F87OMX	18, 20	M22x1.5	45.5	27	5.0		
12M27F87OMX	18, 20	M27x2	49.0	32	5.0	5.0	
16M27F87OMX	25	M27x2	50.5	36	5.0		
16M33F87OMX	25	M33x2	51.6	41	4.0		
20M42F87OMX	30, 32	M42x2	54.9	50	4.0		
24M48F87OMX	38	M48x2	59.4	55	3.0		

F82EDMX Full Dimensions

Male Connector – Metric
37° Flare / Metric-ED

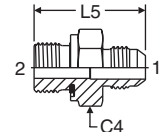

TUBE FITTING PART #	END SIZE		C4 (mm)	L5 (mm)	STANDARD Dynamic Pressure (x 1,000 PSI)		
	1 (mm)	2 Male Metric Parallel Thread			-S	-SS	-B
5M12F82EDMX	8	M12x1.5	17	33.5	6.0		
6M14F82EDMX	10	M14x1.5	19	33.5	6.0		
6M16F82EDMX	10	M16x1.5	22	35.1	6.0		
8M16F82EDMX	12	M16x1.5	22	37.6	6.0		
8M18F82EDMX	12	M18x1.5	24	39.1	5.0		
10M18F82EDMX	14, 15, 16	M18x1.5	24	41.7	5.0		
10M22F82EDMX	14, 15, 16	M22x1.5	27	42.9	5.0		
12M22F82EDMX	18, 20	M22x1.5	27	45.5	5.0		
12M27F82EDMX	18, 20	M27x2	32	49.0	5.0		
16M27F82EDMX	25	M27x2	36	52.7	4.5		
16M33F82EDMX	25	M33x2	41	51.6	4.0		
20M42F82EDMX	30, 32	M42x2	50	54.9	4.0		

- How to Order
- Specs
- Assembly / Installation
- 3-D CAD Model
- Reference

F8OMX Full Dimensions

Male Connector – Metric
37° Flare / Metric-ORR

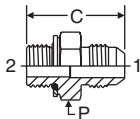

TUBE FITTING PART #	END SIZE		C (mm)	P (mm)	STANDARD Dynamic Pressure (x 1,000 PSI)		
	1 (mm)	2 Male Metric Parallel Thread			-S	-SS	-B
5M12F8OMX	8	M12x1.5	33.5	19	5.0		
6M14F8OMX	10	M14x1.5	33.5	19	5.0		
8M16F8OMX	12	M16x1.5	37.6	22	5.0		
8M18F8OMX	12	M18x1.5	39.1	24	3.6		
10M18F8OMX	14, 15, 16	M18x1.5	41.7	24	3.6		
10M20F8OMX	14, 15, 16	M20x1.5	44.6	27	3.0		
10M22F8OMX	14, 15, 16	M22x1.5	42.9	27	3.6		
12M22F8OMX	18, 20	M22x1.5	45.5	27	3.6		
12M24F8OMX	18, 20	M24x1.5	44.5	30	3.0		
12M27F8OMX	18, 20	M27x2	49.0	32	3.0		
16M27F8OMX	25	M27x2	50.5	36	3.0		
16M33F8OMX	25	M33x2	51.6	41	3.0		
20M42F8OMX	30, 32	M42x2	54.9	50	3.0		
24M48F8OMX	38	M48x2	59.4	55			

Note: If F8OMX is not available, use F82EDMX.

F42EDMX Full Dimensions

Male Connector – BSPP
37° Flare / BSPP-ED

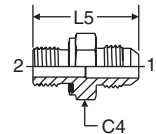

TUBE FITTING PART #	END SIZE		C4 (mm)	L5 (mm)	STANDARD Dynamic Pressure (x 1,000 PSI)		
	1 (mm)	2 BSPP			-S	-SS	-B
4-4F42EDMX	6	1/4-19	19	34.8	6.0		
4-6F42EDMX	6	3/8-19	22	35.7	6.0		
4-8F42EDMX	6	1/2-14	30	39.2	5.0		
5F42EDMX	8	1/8-28	14	30.0	6.0		
5-4F42EDMX	8	1/4-19	19	34.8	6.0		
5-6F42EDMX	8	3/8-19	22	35.7	6.0		
6-2F42EDMX	10	1/8-28	16	31.0	6.0		
6F42EDMX	10	1/4-19	19	35.1	6.0		
6-6F42EDMX	10	3/8-19	22	36.0	6.0		
6-8F42EDMX	10	1/2-14	30	39.4	5.0		
8F42EDMX	12	3/8-19	22	33.5	6.0		
8-4F42EDMX	12	1/4-19	19	38.7	6.0		
8-8F42EDMX	12	1/2-14	30	42.0	5.0		
8-12F42EDMX	12	3/4-14	36	45.6	5.0		
10F42EDMX	14, 15, 16	1/2-14	30	44.5	5.0		
10-6F42EDMX	14, 15, 16	3/8-19	24	42.6	5.0		
10-12F42EDMX	14, 15, 16	3/4-14	32	48.1	5.0		
12F42EDMX	18, 20	3/4-14	36	50.9	5.0		
12-6F42EDMX	18, 20	3/8-19	27	50.1	5.0		
12-8F42EDMX	18, 20	1/2-14	30	49.0	5.0		
12-16F42EDMX	18, 20	1-11	46	53.4	4.0		
16F42EDMX	25	1-11	46	54.7	4.0		
16-12F42EDMX	25	3/4-14	36	52.7	4.5		
16-20F42EDMX	25	1 1/4-11	50	58.7	4.0		
20-16F42EDMX	30, 32	1-11	46	62.1	4.0		
20F42EDMX	30, 32	1 1/4-11	50	60.0	4.0		
20-24F42EDMX	30, 32	1 1/2-11	55	63.8	3.0		
24F42EDMX	38	1 1/2-11	55	67.1	3.0		
24-20F42EDMX	38	1 1/4-11	50	63.8	3.0		



F4OMX Full Dimensions

Male Connector – BSPP
37° Flare / BSPP-ORR

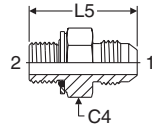

TUBE FITTING PART #	END SIZE		C4 (mm)	L5 (mm)	STANDARD Dynamic Pressure (x 1,000 PSI)		
	1 (mm)	2 BSPP			-S	-SS	-B
4-4F4OMX	6	1/4-19	19	32.0	5.0		
4-6F4OMX	6	3/8-19	22	33.0	5.0		
4-8F4OMX	6	1/2-14	30	38.6	5.0		
5-4F4OMX	8	1/4-19	19	32.0	5.0		
5-6F4OMX	8	3/8-19	22	33.0	5.0		
6F4OMX	10	1/4-19	19	32.0	5.0		
6-6F4OMX	10	3/8-19	22	33.0	5.0		
6-8F4OMX	10	1/2-14	30	38.6	5.0		
8-4F4OMX	12	1/4-19	19	35.0	5.0		
8F4OMX	12	3/8-19	22	36.0	5.0		
8-8F4OMX	12	1/2-14	30	41.4	5.0		
8-12F4OMX	12	3/4-14	36	42.4	4.0		
10-6F4OMX	14, 15, 16	3/8-19	24	39.1	5.0		
10F4OMX	14, 15, 16	1/2-14	30	43.9	5.0		
12-8F4OMX	18, 20	1/2-14	30	46.7	5.0		
12F4OMX	18, 20	3/4-14	36	47.5	4.0		
12-16F4OMX	18, 20	1-11	46	52.6	4.0		
16-12F4OMX	25	3/4-14	36	48.5	4.0		
16F4OMX	25	1-11	46	53.6	4.0		
16-20F4OMX	25	1 1/4-11	50	55.1	3.6		
20F4OMX	30, 32	1 1/4-11	50	56.9	3.6		
24-20F4OMX	38	1 1/4-11	50	60.4	3.0		
24F4OMX	38	1 1/2-11	55	61.0	3.0		

Note: If F4OMX is not available, use F42EDMX.

G4MX Full Dimensions

Female Connector – BSPP
37° Flare / BSPP

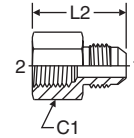

TUBE FITTING PART #	END SIZE		C1 (mm)	L2 (mm)	STANDARD Dynamic Pressure (x 1,000 PSI)		
	1 (in.)	2 BSPP			-S	-SS	-B
4-4G4MX	6	1/4-19	19	35.3	5.0		
5G4MX	8	1/8-28	16	29.7	5.0		
6G4MX	10	1/4-19	19	35.6	5.0		
6-6G4MX	10	3/8-19	22	37.1	5.0		
8G4MX	12	3/8-19	22	39.6	5.0		
8-8G4MX	12	1/2-14	30	45.5	5.0		
10G4MX	14, 15, 16	1/2-14	30	48.0	5.0		
12G4MX	18, 20	3/4-14	36	52.3	4.0		
16G4MX	25	1-11	46	59.7	4.0		

- How to Order
- Specs
- Assembly / Installation
- 3-D CAD Model
- Reference

F3MX Full Dimensions

Male Connector – BSPT
37° Flare / BSPT

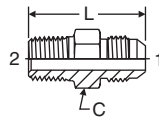

TUBE FITTING PART #	END SIZE		C HEX (mm)	L (mm)	STANDARD Dynamic Pressure (x 1,000 PSI)		
	1 (mm)	2 BSPT			-S	-SS	-B
4-4F3MX	6	1/4-19	14	36.0	4.5		
5F3MX	8	1/8-28	14	31.0	4.5		
5-4F3MX	8	1/4-19	14	36.0	4.5		
6F3MX	10	1/4-19	16	36.3	4.5		
6-6F3MX	10	3/8-19	19	36.4	4.5		
6-8F3MX	10	1/2-14	22	42.9	4.5		
8-4F3MX	12	1/4-19	19	38.9	4.5		
8F3MX	12	3/8-19	19	38.9	4.5		
8-8F3MX	12	1/2-14	22	45.5	4.5		
10-6F3MX	14, 15, 16	3/8-19	24	43.2	4.5		
10F3MX	14, 15, 16	1/2-14	24	48.0	4.5		
10-12F3MX	14, 15, 16	3/4-14	27	49.5	2.3		
12-8F3MX	18, 20	1/2-14	27	52.3	4.5		
12F3MX	18, 20	3/4-14	27	52.3	2.3		
12-16F3MX	18, 20	1-11	36	57.1	2.3		
16-12F3MX	25	3/4-14	36	53.6	2.3		
16F3MX	25	1-11	36	58.4	2.3		
20-16F3MX	30, 32	1-11	46	61.4	2.3		
20F3MX	30, 32	1 1/4-11	46	62.2	2.3		
24F3MX	38	1 1/2-11	50	68.1	2.3		

HX6 Full Dimensions

Swivel Nut Union
37° Swivel / 37° Swivel

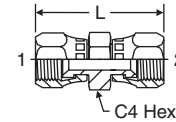

HPD Base # 0606

TUBE FITTING PART #	END SIZE 1 & 2 (in.)	C4 HEX (in.)	L (in.)	STANDARD Dynamic Pressure (x 1,000 PSI)		
				-S	-SS	-B
	4 HX6	1/4	9/16	1.48	7.5	
6 HX6	3/8	11/16	1.75	5.0		
8 HX6	1/2	7/8	2.02	5.0		
10 HX6	5/8	1	2.24	5.0		
12 HX6	3/4	1 1/4	2.43	5.0		
16 HX6	1	1 1/2	2.68	3.6		



F650X Full Dimensions

Swivel Straight Thread Connector
37° Swivel / SAE-ORB

HPD Base # 0506

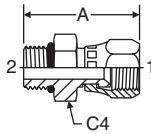

TUBE FITTING PART #	END SIZE		A (in.)	C4 HEX (in.)	STANDARD Dynamic Pressure (x 1,000 PSI)		
	1 (in.)	2 UN/UNF-2B			-S	-SS	-B
	4 F650X	1/4					
4-6 F650X	1/4	9/16-18	1.37	11/16	6.0		
5 F650X	5/16	1/2-20	1.35	0.625	6.0		
6 F650X	3/8	9/16-18	1.43	11/16	6.0	6.0	
6-4 F650X	3/8	9/16-18	1.37	9/16	6.0		
6-8 F650X	3/8	3/4-16	1.50	7/8	5.0	6.0	
8 F650X	1/2	3/4-16	1.61	7/8	5.0	6.0	
8-6 F650X	1/2	9/16-18	1.54	13/16	5.0		
8-10 F650X	1/2	3/4-16	1.88	7/8	5.0		
10 F650X	5/8	7/8-14	1.84	1 1/16	5.0	6.0	
10-8 F650X	5/8	3/4-16	1.67	1	5.0		
10-12 F650X	5/8	1 1/16-12	1.92	1 1/4	5.0		
12 F650X	3/4	1 1/16-12	2.07	1 1/4	5.0	6.0	
12-10 F650X	3/4	7/8-14	2.10	1 1/4	5.0		
12-16 F650X	3/4	1 1/16-12	2.24	1 1/2	3.6		
16 F650X	1	1 5/16-12	2.28	1 1/2	3.6	4.3	
16-12 F650X	1	1 5/16-12	2.14	1 1/2	4.5		
20 F650X	1 1/4	1 5/8-12	2.49	2	3.6	4.3	

F6X Full Dimensions

Swivel Connector
37° Swivel / NPTF

HPD Base # 0106

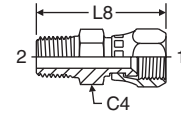

TUBE FITTING PART #	END SIZE		C4 (in.)	L8 (in.)	STANDARD Dynamic Pressure (x 1,000 PSI)		
	1 (in.)	2 NPTF			-S	-SS	-B
	4 F6X	1/4					
4-4 F6X	1/4	1/4-18	9/16	1.46	6.0	6.0	
5-4 F6X	5/16	1/4-18	5/8	1.57	6.0		
6 F6X	3/8	1/4-18	11/16	1.59	5.0	5.0	
6-6 F6X	3/8	3/8-18	3/4	1.59	5.0	5.0	
8 F6X	1/2	3/8-18	7/8	1.69	5.0	5.0	
8-8 F6X	1/2	1/2-14	7/8	1.92	5.0	5.0	
10 F6X	5/8	1/2-14	1	2.05	5.0	5.0	
10-6 F6X	5/8	3/8-18	1	1.87	5.0	5.0	
12 F6X	3/4	3/4-14	1 1/4	2.15	5.0	5.0	
12-8 F6X	3/4	1/2-14	1 1/4	2.15	5.0	5.0	
16 F6X	1	1-11 1/2	1 1/2	2.50	3.6	3.6	
16-12 F6X	1	3/4-14	1 1/2	2.33	3.6		
20 F6X	1 1/4	1 1/4-11 1/2	2	2.76	3.0	3.0	
24 F6X	1 1/2	1 1/2-11 1/2	2 1/4	3.05	2.5	2.5	
32 F6X	2	2-11 1/2	2 5/8	3.38		2.0	

G6X Full Dimensions

Swivel Nut Female Connector
37° Swivel / NPTF

HPD Base # 0206

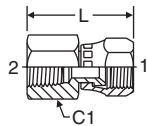

TUBE FITTING PART #	END SIZE		C1 (in.)	L (in.)	STANDARD Dynamic Pressure (x 1,000 PSI)		
	1 (in.)	2 NPTF			-S	-SS	-B
	4 G6X	1/4					
4-4 G6X	1/4	1/4-18	3/4	1.43	6.0	6.0	
6 G6X	3/8	1/4-18	3/4	1.44	5.0	5.0	
6-6 G6X	3/8	3/8-18	7/8	1.54	5.0	5.0	
6-8 G6X	3/8	1/2-14	1 1/8	1.80	5.0	5.0	
8 G6X	1/2	3/8-18	7/8	1.69	5.0	5.0	
8-8 G6X	1/2	1/2-14	1 1/8	1.94	5.0	5.0	
10 G6X	5/8	1/2-14	1 1/8	1.98	5.0	5.0	
12 G6X	3/4	3/4-14	1 3/8	2.08	4.0	4.0	
12-8 G6X	3/4	1/2-14	1 1/4	2.07		5.0	
16 G6X	1	1-11 1/2	1 5/8	2.45	3.0	3.0	
20 G6X	1 1/4	1 1/4-11 1/2	2	2.81	2.5	2.5	
24 G6X	1 1/2	1 1/2-11 1/2	2 3/8	3.01	2.0	2.0	
32 G6X	2	2-11 1/2	2 7/8	3.40	1.5	1.5	

F6870MX Full Dimensions

Swivel – ISO 6149 Connector
37° Swivel / ISO 6149

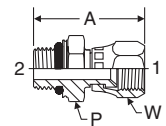

TUBE FITTING PART #	END SIZE		A (mm)	P (mm)	W (mm)	STANDARD Dynamic Pressure (x 1,000 PSI)		
	1 (mm)	2 Male Metric Parallel Thread				-S	-SS	-B
	4M10F6870MX	6						
5M12F6870MX	8	M12x1.5	44.0	22	22	6.0		
6M14F6870MX	10	M14x1.5	45.7	22	24	5.0		
8M16F6870MX	12	M16x1.5	46.6	27	27	5.0		
10M22F6870MX	14, 15, 16	M22x1.5	48.6	27	27	5.0		
12M27F6870MX	18, 20	M27x2	53.9	32	32	5.0		
16M33F6870MX	25	M33x2	57.5	38	41	3.6		



F682EDMX Full Dimensions

Metric-ED / 37° Swivel

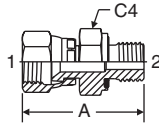

F642EDMX Full Dimensions

Swivel – BSPP Connector
37° Swivel / BSPP-ED

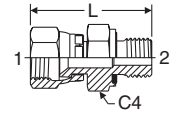

TUBE FITTING PART #	END SIZE		A (mm)	C4 (mm)	STANDARD Dynamic Pressure (x 1,000 PSI)		
	1 (mm)	2 Male Metric Parallel Thread			-S	-SS	-B
	4M10F682EDMX	6					
5M12F682EDMX	8	M12 x 1.5	28.8	17	6.0		
6M14F682EDMX	10	M14 x 1.5	30.4	19	5.0		
8M16F682EDMX	12	M16 x 1.5	33.5	22	5.0		
10M22F682EDMX	14, 15, 16	M22 x 1.5	37.6	27	5.0		
12M27F682EDMX	18, 20	M27 x 2	41.5	32	5.0		
16M33682EDMX	18, 20	M33 x 2	45.2	41	3.6		

TUBE FITTING PART #	END SIZE		C4 (mm)	L (mm)	STANDARD Dynamic Pressure (x 1,000 PSI)		
	1 (mm)	2 BSPP			-S	-SS	-B
	4F642EDMX	6					
4-4F642EDMX	6	1/4-19	19	28.8	7.2		
5F642EDMX	8	1/8-28	14	24.7	6.0		
5-4F642EDMX	8	1/4-19	19	29.4	6.0		
6F642EDMX	10	1/4-19	19	30.4	5.0	5.0	
6-6F642EDMX	10	3/8-19	22	31.3	5.0		
8F642EDMX	12	3/8-19	22	21.2	5.0	5.0	
8-4F642EDMX	12	1/4-19	19	33.4	5.0		
10F642EDMX	14, 15, 16	1/2-14	27	23.4	5.0	5.0	
10-6F642EDMX	14, 15, 16	3/8-19	22	35.4	5.0		
12F642EDMX	18, 20	3/4-14	32	41.5	5.0	5.0	
12-8F642EDMX	18, 20	1/2-14	27	39.7	5.0		
16F642EDMX	25	1-11	41	45.2	3.6		
16-12F642EDMX	25	3/4-14	32	43.2	3.6		
20F642EDMX	28, 30, 32	1 1/4-11	50	52.0	3.6		
20-16F642EDMX	28, 30, 32	1-11	41	54.0	3.6		
24F642EDMX	35, 38	1 1/2-11	55	57.9	2.5		
24-20F642EDMX	35, 38	1 1/4-11	50	60.0	2.5		

F63MX Full Dimensions

Swivel – BSPT Connector
37° Swivel / BSPT

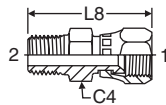

TUBE FITTING PART #	END SIZE		C4 (mm)	L8 (mm)	STANDARD Dynamic Pressure (x 1,000 PSI)		
	1 (mm)	2 BSPT			-S	-SS	-B
	4F63MX	6					
4-4F63MX	6	1/8-28	13	34.1	4.5		
5F63MX	8	1/8-28	14	34.1	4.5		
5-4F63MX	8	1/4-19	14	38.4	4.5		
6F63MX	10	1/4-19	14	40.3	4.5		
6-6F63MX	10	3/8-19	19	40.6	4.5		
8F63MX	12	3/8-19	19	42.8	4.5		
8-4F63MX	12	1/4-19	19	42.8	4.5		
10F63MX	14, 15, 16	1/2-14	22	51.2	4.5		
12F63MX	18, 20	3/4-14	27	54.6	2.3		
12-8F63MX	20	1/2-14	27	54.6	4.5		
16-12F63MX	25	3/4-14	32	58.9	2.3		
16F63MX	25	1-11	36	63.8	2.3		
20F63MX	30, 32	1 1/4-11	46	69.0	2.3		



WNTX Full Dimensions

45° Bulkhead Union Elbow
37° Flare / 37° Flare

SAE 070801
HPD Base # 3353
WNTX-WLN – Body with locknut
(See page C10 for WLN)

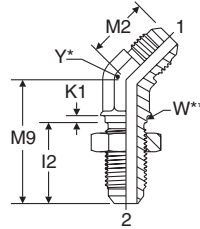

Y* – Across wrench flats.
W** – Bulkhead pilot dia.
recommended clearance hole
+.015 over W dia.

TUBE FITTING PART #	END SIZE						MAX. BULKHEAD WALL THICKNESS (in.)	Y (in.)	STANDARD Dynamic Pressure (x 1,000 PSI)		
	1 & 2 (in.)	I 2 (in.)	K1 (in.)	M2 (in.)	M9 (in.)	W DIA. (in.)			-S	-SS	-B
	4 WNTX	1/4	1.02	0.09	0.72	1.53					
5 WNTX	5/16	1.02	0.09	0.78	1.66	0.56	9/16	7.5			
6 WNTX	3/8	1.09	0.09	0.83	1.67	0.56	9/16	7.5	6.0		
8 WNTX	1/2	1.25	0.13	0.98	1.94	0.75	3/4	6.0	6.0		
10 WNTX	5/8	1.39	0.13	1.11	2.17	0.82	7/8	5.0			
12 WNTX	3/4	1.56	0.13	1.28	2.44	1.06	1 1/16	5.0	5.0		
16 WNTX	1	1.56	0.13	1.47	2.56	1.31	1 5/16	4.5	3.5		
20 WNTX	1 1/4	1.61	0.13	1.59	2.65	1.63	1 5/8	4.0			

V6X Full Dimensions

45° Swivel Nut Elbow
37° Flare / 37° Swivel

SAE 070321
HPD Base # 3703

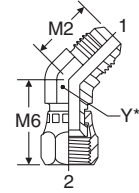

Y* – Across wrench flats

TUBE FITTING PART #	END SIZE		M2 (in.)	M6 (in.)	Y (in.)	STANDARD Dynamic Pressure (x 1,000 PSI)		
	1 & 2 (in.)					-S	-SS	-B
	4 V6X	1/4						
5 V6X	5/16		0.77	1.00	9/16	6.0		
6 V6X	3/8		0.83	1.12	9/16	5.0	6.0	
8 V6X	1/2		0.98	1.28	3/4	5.0	6.0	
10 V6X	5/8		1.11	1.44	7/8	5.0	5.0	
12 V6X	3/4		1.28	1.50	1 1/16	5.0	5.0	
14 V6X	7/8		1.39	1.62	1 3/16	4.0		
16 V6X	1		1.47	1.75	1 5/16	3.6	2.5	
20 V6X	1 1/4		1.59	2.03	1 5/8	3.6	2.5	
24 V6X	1 1/2		1.78	2.27	1 7/8	2.5		
32 V6X	2		2.22	2.76	2 1/2	1.5	1.5	

V50X Full Dimensions

45° Straight Thread Elbow
37° Flare / SAE-ORB

SAE 070320
HPD Base # 3503

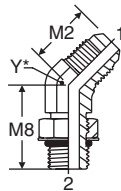

Y* – Across wrench flats

TUBE FITTING PART #	END SIZE					STANDARD Dynamic Pressure (x 1,000 PSI)		
	1 (in.)	2 UN/UNF-2A	M2 (in.)	M8 (in.)	Y (in.)	-S	-SS	-B
	4 V50X	1/4	7/16-20	0.72	1.05			
4-6 V50X	1/4	9/16-18	0.82	1.14	9/16	6.0		
5 V50X	5/16	1/2-20	0.77	1.05	9/16	6.0		
6 V50X	3/8	9/16-18	0.83	1.14	9/16	6.0	5.4	
6-4 V50X	3/8	7/16-20	0.83	1.08	9/16	6.0		
6-8 V50X	3/8	3/4-16	0.86	1.30	3/4	6.0		
8 V50X	1/2	3/4-16	0.98	1.30	3/4	6.0	5.4	
8-6 V50X	1/2	9/16-18	0.98	1.09	3/4	6.0	5.4	
8-10 V50X	1/2	7/8-14	1.00	1.52	7/8	5.0	5.4	
8-12 V50X	1/2	1 1/16-12	1.06	1.66	1 1/16	5.0		
10 V50X	5/8	7/8-14	1.11	1.52	7/8	5.0	5.4	
10-8 V50X	5/8	3/4-16	1.11	1.38	7/8	5.0		
10-12 V50X	5/8	1 1/16-12	1.16	1.73	1 1/16	5.0		
12 V50X	3/4	1 1/16-12	1.28	1.73	1 1/16	5.0	5.4	
12-10 V50X	3/4	7/8-14	1.28	1.58	1 1/16	5.0	5.4	
12-16 V50X	3/4	1 5/16-12	1.42	1.86	1 5/16	4.0		
14 V50X	7/8	1 3/16-12	1.45	1.86	1 5/16	5.0		
16 V50X	1	1 5/16-12	1.47	1.86	1 5/16	4.0	3.0	
16-12 V50X	1	1 1/16-12	1.47	1.86	1 5/16	4.0		
16-20 V50X	1	1 5/8-12	1.55	1.91	1 5/8	4.0		
20 V50X	1 1/4	1 5/8-12	1.59	1.91	1 5/8	4.0	2.5	
20-16 V50X	1 1/4	1 5/16-12	1.59	1.91	1 5/8	4.0		
24 V50X	1 1/2	1 7/8-12	1.78	1.91	1 7/8	3.0		
32 V50X	2	2 1/2-12	2.22	1.86	2 1/2	2.0		

V870MX Full Dimensions

Male 45° Elbow – ISO 6149
37° Flare / ISO 6149

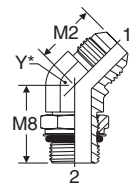

Y* – Across wrench flats

TUBE FITTING PART #	END SIZE		M2 (mm)	M8 (mm)	Y (mm)	STANDARD Dynamic Pressure (x 1,000 PSI)		
	1 (mm)	2 Male Metric Parallel Thread				-S	-SS	-B
	4M12V870MX	6						
6M14V870MX	10	M14x1.5	21.1	28.0	14	6.0		
8M16V870MX	12	M16x1.5	24.9	32.1	19	5.0		
10M22V870MX	14, 15, 16	M22x1.5	28.2	37.2	22	5.0		
12M27V870MX	18, 20	M27x2.0	32.5	43.2	27	5.0		
16M33V870MX	25	M33x2.0	37.3	46.5	33	4.0		



How to Order

Specs

Assembly / Installation

3-D CAD Model

Reference

VTX Full Dimensions

45° Male Elbow
37° Flare / NPTF

SAE 070302
HPD Base # 3103

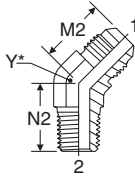

Y* – Across wrench flats

TUBE FITTING PART #	END SIZE		M2 (in.)	N2 (in.)	Y (in.)	STANDARD Dynamic Pressure (x 1,000 PSI)		
	1 (in.)	2 NPTF				-S	-SS	-B
	2 VTX	1/8						
3 VTX	3/16	1/8-27	0.69	0.53	7/16	6.0		
4 VTX	1/4	1/8-27	0.72	0.64	7/16	6.0	6.0	3.3
4-4 VTX	1/4	1/4-18	0.82	0.86	9/16	6.0	6.0	3.3
4-6 VTX	1/4	3/8-18	0.92	0.95	3/4	6.0		
5 VTX	5/16	1/8-27	0.77	0.64	9/16	6.0	6.0	3.3
5-4 VTX	5/16	1/4-18	0.82	0.86	9/16	6.0	6.0	
6 VTX	3/8	1/4-18	0.83	0.86	9/16	6.0	6.0	3.3
6-2 VTX	3/8	1/8-27	0.83	0.67	9/16	6.0	6.0	3.3
6-6 VTX	3/8	3/8-18	0.87	0.95	3/4	6.0	6.0	3.3
6-8 VTX	3/8	1/2-14	1.06	1.17	7/8	6.0	6.0	
8 VTX	1/2	3/8-18	0.98	0.95	3/4	6.0	6.0	3.3
8-4 VTX	1/2	1/4-18	0.98	0.95	3/4	6.0	6.0	
8-8 VTX	1/2	1/2-14	0.99	1.17	7/8	6.0	6.0	3.3
8-12 VTX	1/2	3/4-14	1.04	1.20	1 1/16	4.0	4.0	
10 VTX	5/8	1/2-14	1.11	1.17	7/8	5.0	5.0	3.3
10-6 VTX	5/8	3/8-18	1.11	0.98	7/8	5.0	5.0	
10-12 VTX	5/8	3/4-14	1.28	1.20	1 1/16	4.0		
12 VTX	3/4	3/4-14	1.28	1.20	1 1/16	4.0	4.0	2.6
12-8 VTX	3/4	1/2-14	1.28	1.20	1 1/16	5.0	5.0	
12-16 VTX	3/4	1-11 1/2	1.42	1.48	1 5/16	3.0		
14 VTX	7/8	3/4-14	1.39	1.27	1 5/16	4.0		
16 VTX	1	1-11 1/2	1.47	1.48	1 5/16	3.0	3.0	2.0
16-12 VTX	1	3/4-14	1.47	1.29	1 5/16	4.0	4.0	
16-20 VTX	1	1 1/4-11 1/2	1.59	1.67	1 5/8	2.5		
20 VTX	1 1/4	1 1/4-11 1/2	1.59	1.67	1 5/8	2.5	2.5	
20-16 VTX	1 1/4	1-11 1/2	1.59	1.63	1 5/8	3.0		
24 VTX	1 1/2	1 1/2-11 1/2	1.78	1.77	1 7/8	2.5	2.5	
32 VTX	2	2-11 1/2	2.22	2.11	2 1/2	2.0		

V40MX Full Dimensions

Male 45° Elbow – BSPP
37° Flare / BSPP-ORR

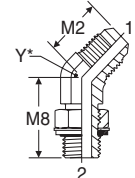

Y* – Across wrench flats

TUBE FITTING PART #	END SIZE		M2 (mm)	M8 (mm)	Y (mm)	STANDARD Dynamic Pressure (x 1,000 PSI)		
	1 (mm)	2 BSPP				-S	-SS	-B
	4V40MX	6						
6V40MX	10	1/4-19	21.1	29.0	14	3.6		
8V40MX	12	3/8-19	24.9	33.0	19	3.6		
10V40MX	14,15,16	1/2-14	28.2	38.6	22	3.6		
12V40MX	18,20	3/4-14	32.5	43.9	27	3.6		
16V40MX	25	1-11	37.2	47.2	33	3.6		

ETX Full Dimensions

Union Elbow
37° Flare / 37° Flare

SAE 070201
HPD Base # 2303

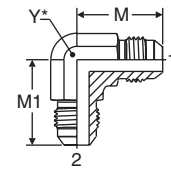

Y* – Across wrench flats

TUBE FITTING PART #	END SIZE		M (in.)	M1 (in.)	Y (in.)	STANDARD Dynamic Pressure (x 1,000 PSI)		
	1 (in.)	2 (in.)				-S	-SS	-B
	2 ETX	1/8						
3 ETX	3/16	3/16	0.83	0.83	7/16		7.7	
4 ETX	1/4	1/4	0.89	0.89	7/16	7.5	7.7	3.3
5 ETX	5/16	5/16	0.95	0.95	9/16	6.0	6.0	3.3
6 ETX	3/8	3/8	1.06	1.06	9/16	6.0	6.0	3.3
6-4 ETX	3/8	1/4	1.06	1.05	9/16	6.0		
8 ETX	1/2	1/2	1.25	1.25	3/4	6.0	6.0	3.3
8-6 ETX	1/2	3/8	1.25	1.14	3/4	6.0		
10 ETX	5/8	5/8	1.45	1.45	7/8	5.0	5.0	3.3
10-8 ETX	5/8	1/2	1.45	1.33	7/8	5.0		
12 ETX	3/4	3/4	1.66	1.66	1 1/16	5.0	5.0	3.3
12-8 ETX	3/4	1/2	1.66	1.42	1 1/16			
12-10 ETX	3/4	5/8	1.66	1.54	1 1/16		5.0	
14 ETX	7/8	7/8	1.73	1.73	1 3/16	5.0		
16 ETX	1	1	1.81	1.81	1 5/16	4.0	3.5	2.3
16-12 ETX	1	3/4	1.81	1.77	1 5/16			
20 ETX	1 1/4	1 1/4	2.06	2.06	1 5/8	4.0	3.0	
24 ETX	1 1/2	1 1/2	2.33	2.33	1 7/8	3.0	2.0	
32 ETX	2	2	3.06	3.06	2 1/2	2.0	1.5	

V3MX Full Dimensions

Male 45° Elbow – BSPT
37° Flare / BSPT

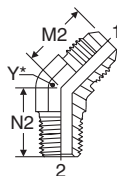

Y* – Across wrench flats

TUBE FITTING PART #	END SIZE		M2 (mm)	N2 (mm)	Y (mm)	STANDARD Dynamic Pressure (x 1,000 PSI)		
	1 (mm)	2 BSPT				-S	-SS	-B
	4V3MX	6						
4-4V3MX	6	1/4-19	20.8	21.8	14	4.5		
6V3MX	10	1/4-19	21.1	21.8	14	4.5		
6-6V3MX	10	3/8-19	22.1	24.1	19	4.5		
8V3MX	12	3/8-19	24.9	24.1	19	4.5		
8-8V3MX	12	1/2-14	25.2	29.7	22	4.5		
12V3MX	18, 20	3/4-14	32.5	30.5	27	2.3		

How to Order

Specs

Assembly / Installation

3-D CAD Model

Reference

WETX Full Dimensions

Bulkhead Union Elbow
37° Flare / 37° Flare

SAE 070701
HPD Base # 2353
WETX-WLN – Body with locknut
(See page C10 for WLN)

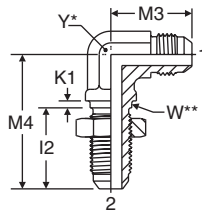

Y* – Across wrench flats.
W** – Bulkhead pilot dia.
recommended clearance hole
+.015 over W dia.

TUBE FITTING PART #	END SIZE						MAX. BULKHEAD WALL THICKNESS (in.)	Y (in.)	STANDARD Dynamic Pressure (x 1,000 PSI)		
	1 & 2 (in.)	12 (in.)	K1 (in.)	M3 (in.)	M4 (in.)	W DIA. (in.)			-S	-SS	-B
	3 WETX	3/16	0.92	0.09	0.94	1.50					
4 WETX	1/4	1.02	0.09	0.97	1.59	0.44	0.21	7/16	7.5	7.7	3.3
5 WETX	5/16	1.02	0.09	1.06	1.72	0.50	0.21	9/16	6.0	6.0	3.3
6 WETX	3/8	1.09	0.09	1.09	1.81	0.56	0.28	9/16	6.0	6.0	3.3
8 WETX	1/2	1.25	0.13	1.36	2.11	0.75	0.33	3/4	6.0	6.0	3.3
10 WETX	5/8	1.39	0.13	1.56	2.39	0.88	0.32	7/8	5.0	5.0	
12 WETX	3/4	1.56	0.13	1.78	2.67	1.06	0.34	1 1/16	5.0	5.0	
14 WETX	7/8	1.56	0.13	1.92	2.80	1.19	0.31	1 5/8	5.0		
16 WETX	1	1.56	0.13	1.94	2.80	1.31	0.29	1 5/8	4.0	3.5	
20 WETX	1 1/4	1.61	0.13	2.17	3.13	1.63	0.29	1 5/8	4.0	3.0	

C6X Full Dimensions

Swivel Nut Elbow
37° Flare / 37° Swivel

SAE 070221
HPD Base # 3903

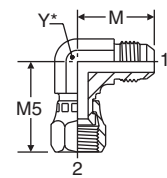

Y* – Across wrench flats

TUBE FITTING PART #	END SIZE				STANDARD Dynamic Pressure (x 1,000 PSI)		
	1 & 2 (in.)	M (in.)	M5 (in.)	Y (in.)	-S	-SS	-B
	3 C6X	3/16	0.83	1.00			
4 C6X	1/4	0.89	1.00	7/16	7.5	7.7	
5 C6X	5/16	0.95	1.06	9/16	6.0		
6 C6X	3/8	1.06	1.25	9/16	5.0	6.0	
8 C6X	1/2	1.25	1.38	3/4	5.0	6.0	
10 C6X	5/8	1.45	1.62	7/8	5.0	5.0	
12 C6X	3/4	1.66	1.75	1 1/16	5.0	5.0	
14 C6X	7/8	1.80	1.78	1 5/16	4.0		
16 C6X	1	1.81	2.00	1 5/16	3.6	2.5	
20 C6X	1 1/4	2.06	2.31	1 5/8	3.6	2.5	
24 C6X	1 1/2	2.33	2.59	1 7/8	2.5	2.0	
32 C6X	2	3.06	3.51	2 1/2	1.5	1.5	

AOEX6 Full Dimensions

Swivel Elbow Straight
Thread Connector
SAE-ORB / 37° Swivel

HPD Base # 2506

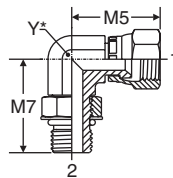

Y* – Across wrench flats

TUBE FITTING PART #	END SIZE		M5 (in.)	M7 (in.)	Y (in.)	STANDARD Dynamic Pressure (x 1,000 PSI)		
	1 (in.)	2 UN/UNF-2A				-S	-SS	-B
	4 AOEX6	1/4						
6 AOEX6	3/8	9/16-18	1.27	1.25	9/16	5.0		
8 AOEX6	1/2	3/4-16	1.34	1.45	3/4	5.0		
10 AOEX6	5/8	7/8-14	1.62	1.70	7/8	5.0		
12 AOEX6	3/4	1 1/16-12	1.75	1.94	1 1/16	5.0		
16 AOEX6	1	1 5/16-12	2.01	2.05	1 5/16	3.6		



X6EF Full Dimensions

Swivel Elbow Connector
37° Swivel / NPTF

HPD Base # 2106

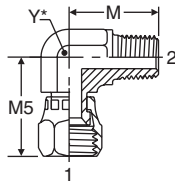

Y* – Across wrench flats

TUBE FITTING PART #	END SIZE		M (in.)	M5 (in.)	Y (in.)	STANDARD Dynamic Pressure (x 1,000 PSI)		
	1 (in.)	2 NPTF				-S	-SS	-B
	4 X6EF	1/4				1/8-27	0.78	1.01
4-4 X6EF	1/4	1/4-18	1.09	1.13	9/16	6.0	6.0	
6 X6EF	3/8	1/4-18	1.09	1.27	9/16	5.0	5.0	
6-6 X6EF	3/8	3/8-18	1.22	1.27	3/4	5.0	5.0	
8 X6EF	1/2	3/8-18	1.22	1.34	3/4	5.0	5.0	
8-8 X6EF	1/2	1/2-14	1.47	1.48	7/8	5.0	5.0	
10 X6EF	5/8	1/2-14	1.47	1.62	7/8	5.0	5.0	
12 X6EF	3/4	3/4-14	1.59	1.75	1 1/16	4.0	4.0	
16 X6EF	1	1-11	1.97	2.01	1 5/16	3.0	3.0	

C5OX Full Dimensions

Straight Thread Elbow
37° Flare / SAE-ORB

SAE 070220

HPD Base # 2503

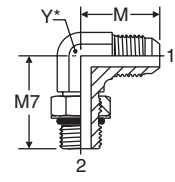

Y* – Across wrench flats

TUBE FITTING PART #	END SIZE		M (in.)	M7 (in.)	Y (in.)	STANDARD Dynamic Pressure (x 1,000 PSI)		
	1 (in.)	2 UN/UNF-2A				-S	-SS	-B
	2 C5OX	1/8				5/16-24	0.78	0.94
3 C5OX	3/16	3/8-24	0.83	0.94	7/16	5.0	6.0	
4 C5OX	1/4	7/16-20	0.89	1.03	7/16	6.0	6.0	
4-2 C5OX	1/4	5/16-24	0.89	0.92	7/16	5.0		
4-6 C5OX	1/4	9/16-18	1.05	1.25	9/16	6.0	5.4	
4-8 C5OX	1/4	3/4-16	1.13	1.45	3/4	6.0	5.4	
5 C5OX	5/16	1/2-20	0.95	1.13	9/16	6.0	5.4	
5-4 C5OX	5/16	7/16-18	0.95	1.13	9/16	6.0		
5-6 C5OX	5/16	9/16-18	1.06	1.25	9/16	6.0		
6 C5OX	3/8	9/16-18	1.06	1.25	9/16	6.0	5.4	
6-4 C5OX	3/8	7/16-20	1.06	1.19	9/16	6.0	5.4	
6-5 C5OX	3/8	1/2-20	1.06	1.19	9/16	6.0		
6-8 C5OX	3/8	3/4-16	1.14	1.45	3/4	6.0	5.4	
6-10 C5OX	3/8	7/8-14	1.23	1.70	7/8	6.0		
8 C5OX	1/2	3/4-16	1.25	1.45	3/4	6.0	5.4	
8-4 C5OX	1/2	7/16-20	1.25	1.26	3/4	6.0	5.4	
8-6 C5OX	1/2	9/16-18	1.25	1.36	3/4	6.0	5.4	
8-10 C5OX	1/2	7/8-14	1.34	1.70	7/8	5.0	5.4	
8-12 C5OX	1/2	1 1/16-12	1.42	1.94	1 1/16	5.0	5.4	
8-16 C5OX	1/2	1 5/16-12	1.52	2.05	1 5/16	4.0	3.0	
10 C5OX	5/8	7/8-14	1.45	1.70	7/8	5.0	5.4	
10-6 C5OX	5/8	9/16-18	1.45	1.41	7/8	5.0		
10-8 C5OX	5/8	3/4-16	1.45	1.55	7/8	5.0	5.4	
10-12 C5OX	5/8	1 1/16-12	1.53	1.94	1 1/16	5.0		
10-16 C5OX	5/8	1 5/16-12	1.64	2.05	1 5/16	4.0		
12 C5OX	3/4	1 1/16-12	1.66	1.94	1 1/16	5.0	5.4	
12-8 C5OX	3/4	3/4-16	1.66	1.63	1 1/16	5.0	5.4	
12-10 C5OX	3/4	7/8-14	1.66	1.78	1 1/16	5.0	5.4	
12-14 C5OX	3/4	1 3/16-12	1.77	2.00	1 5/16	5.0		
12-16 C5OX	3/4	1 5/16-12	1.81	2.05	1 5/16	4.0	3.0	
12-20 C5OX	3/4	1 5/8-12	1.97	2.25	1 5/8	4.0		
14 C5OX	7/8	1 3/16-12	1.73	2.00	1 5/16	5.0		
16 C5OX	1	1 5/16-12	1.81	2.05	1 5/16	4.0	3.0	
16-12 C5OX	1	1 1/16-12	1.81	2.05	1 5/16	4.0	3.0	
16-14 C5OX	1	1 3/16-12	1.81	2.07	1 5/16	4.0		
16-20 C5OX	1	1 5/8-12	2.01	2.25	1 5/8	4.0	2.5	
16-24 C5OX	1	1 7/8-12	2.16	2.39	1 7/8	3.0		
20 C5OX	1 1/4	1 5/8-12	2.06	2.25	1 5/8	4.0	2.5	
20-16 C5OX	1 1/4	1 5/16-12	2.06	2.25	1 5/8	4.0	2.5	
20-24 C5OX	1 1/4	1 7/8-12	2.20	2.39	1 7/8	3.0		
24 C5OX	1 1/2	1 7/8-12	2.33	2.39	1 7/8	3.0	2.0	
24-20 C5OX	1 1/2	1 5/8-12	2.33	2.39	1 7/8	3.0	2.0	
32 C5OX	2	2 1/2-12	3.06	2.89	2 1/2	2.0	1.5	
32-24 C5OX	2	1 7/8-12	3.06	2.89	2 1/2	1.5		

CC5OX Full Dimensions

Long Straight Thread Elbow
37° Flare / SAE-ORB

SAE 071520

HPD Base # 5503

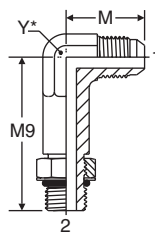

Y* – Across wrench flats

TUBE FITTING PART #	END SIZE		M (in.)	M9 (in.)	Y (in.)	STANDARD Dynamic Pressure (x 1,000 PSI)		
	1 (in.)	2 NPTF				-S	-SS	-B
	4 CC5OX	1/4				7/16-20	0.89	1.73
6 CC5OX	3/8	9/16-18	1.06	2.08	9/16	6.0		
8 CC5OX	1/2	3/4-16	1.25	2.50	7/8	6.0		
10 CC5OX	5/8	7/8-14	1.45	2.89	7/8	5.0		
12 CC5OX	3/4	1 1/16-12	1.66	3.34	1 1/16	5.0		
16 CC5OX	1	1 5/16-12	1.81	3.72	1 5/16	4.0		



CTX Full Dimensions

Male Elbow
37° Flare / NPTF

SAE 070202
HPD Base # 2103

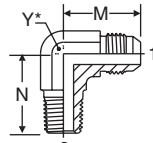

Y* – Across wrench flats

CCTX Full Dimensions

Long Male Elbow
37° Flare / NPTF

SAE 071502
HPD Base # 5603

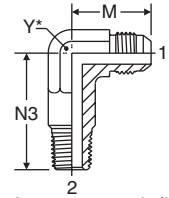

Y* – Across wrench flats

TUBE FITTING PART #	END SIZE		M (in.)	N (in.)	Y (in.)	STANDARD Dynamic Pressure (x 1,000 PSI)		
	1 (in.)	2 NPTF				-S	-SS	-B
	2 CTX	1/8				1/8-27	0.77	0.72
3 CTX	3/16	1/8-27	0.83	0.72	3/8	6.0	6.0	3.3
4 CTX	1/4	1/8-27	0.89	0.78	7/16	6.0	6.0	3.3
4-4 CTX	1/4	1/4-18	1.05	1.09	9/16	6.0	6.0	3.3
4-6 CTX	1/4	3/8-18	1.13	1.22	3/4	6.0	6.0	
4-8 CTX	1/4	1/2-14	1.23	1.44	7/8	6.0	6.0	
5 CTX	5/16	1/8-27	0.95	0.78	9/16	6.0	6.0	3.3
5-4 CTX	5/16	1/4-18	1.05	1.09	9/16	6.0	6.0	3.3
5-6 CTX	5/16	3/8-18	1.13	1.22	3/4	6.0	6.0	
6 CTX	3/8	1/4-18	1.06	1.09	9/16	6.0	6.0	3.3
6-2 CTX	3/8	1/8-27	1.06	0.90	9/16	6.0	6.0	3.3
6-6 CTX	3/8	3/8-18	1.14	1.22	3/4	6.0	6.0	3.3
6-8 CTX	3/8	1/2-14	1.22	1.47	7/8	6.0	6.0	3.3
6-12 CTX	3/8	3/4-14	1.31	1.59	1 1/16	4.0	4.0	
8 CTX	1/2	3/8-18	1.25	1.22	3/4	6.0	6.0	3.3
8-4 CTX	1/2	1/4-18	1.25	1.22	3/4	6.0	6.0	3.3
8-8 CTX	1/2	1/2-14	1.33	1.47	7/8	6.0	6.0	3.3
8-12 CTX	1/2	3/4-14	1.42	1.59	1 1/16	4.0	4.0	2.6
8-16 CTX	1/2	1-11 1/2	1.52	1.97	1 5/16	3.0	3.0	
10 CTX	5/8	1/2-14	1.45	1.47	7/8	5.0	5.0	3.3
10-6 CTX	5/8	3/8-18	1.45	1.28	7/8	5.0	5.0	3.3
10-12 CTX	5/8	3/4-14	1.53	1.59	1 1/16	4.0	4.0	
10-16 CTX	5/8	1-11 1/2	1.64	1.97	1 5/16	3.0	3.0	
12 CTX	3/4	3/4-14	1.66	1.59	1 1/16	4.0	4.0	2.6
12-6 CTX	3/4	3/8-18	1.66	1.41	1 1/16	5.0	5.0	2.9
12-8 CTX	3/4	1/2-14	1.66	1.59	1 1/16	5.0	5.0	2.9
12-16 CTX	3/4	1-11 1/2	1.76	1.97	1 5/16	3.0	3.0	
14 CTX	7/8	3/4-14	1.80	1.69	1 5/16	4.0		2.3
16 CTX	1	1-11 1/2	1.81	1.97	1 5/16	3.0	3.0	2.0
16-8 CTX	1	1/2-14	1.81	1.66	1 5/16	4.0	4.0	2.3
16-12 CTX	1	3/4-14	1.81	1.78	1 5/16	4.0	4.0	2.3
16-20 CTX	1	1 1/4-11 1/2	2.13	2.38	1 5/8	2.5	2.5	
20 CTX	1 1/4	1 1/4-11 1/2	2.06	2.38	1 5/8	2.5	2.5	1.6
20-16 CTX	1 1/4	1-11 1/2	2.06	2.06	1 5/8	3.0	3.0	
20-24 CTX	1 1/4	1 1/2-11 1/2	2.20	2.64	1 7/8	2.5		
24 CTX	1 1/2	1 1/2-11 1/2	2.33	2.64	1 7/8	2.5	2.5	
24-20 CTX	1 1/2	1 1/4-11 1/2	2.33	2.25	1 7/8	2.5	2.5	
24-32 CTX	1 1/2	2-11 1/2	2.81	3.00	2 1/2	2.0		
32 CTX	2	2-11 1/2	3.06	3.00	2 1/2	2.0	2.0	
32-24 CTX	2	1 1/2-11 1/2	3.06	2.97	2 1/2	2.0		
40 CTX	2 1/2	2 1/2-8	2.86	3.57	3 1/4			

TUBE FITTING PART #	END SIZE		M (in.)	N3 (in.)	Y (in.)	STANDARD Dynamic Pressure (x 1,000 PSI)		
	1 (in.)	2 NPTF				-S	-SS	-B
	4 CCTX	1/4				1/8-27	0.89	1.19
4-4 CCTX	1/4	1/4-18	1.05	1.44	9/16	6.0	6.0	
5 CCTX	5/16	1/8-27	0.95	1.17	9/16	6.0		
6 CCTX	3/8	1/4-18	1.06	1.56	9/16	6.0	6.0	3.3
6-6 CCTX	3/8	3/8-18	1.14	1.81	3/4	6.0	6.0	
8 CCTX	1/2	3/8-18	1.25	1.78	3/4	6.0		
8-8 CCTX	1/2	1/2-14	1.34	2.16	7/8	6.0	6.0	
8-12 CCTX	1/2	3/4-14	1.42	2.44	1 1/16	4.0		
10 CCTX	5/8	1/2-14	1.45	2.16	7/8	5.0	5.0	
12 CCTX	3/4	3/4-14	1.66	2.41	1 1/16	4.0	4.0	
14 CCTX	7/8	3/4-14	1.80	2.59	1 5/16			
16 CCTX	1	1-11 1/2	1.81	2.97	1 5/16	3.0	3.0	
20 CCTX	1 1/4	1 1/4-11 1/2	2.06	3.66	1 5/8	2.5	2.5	

CCCTX Full Dimensions

Extra Long Male Elbow
37° Flare / NPTF

SAE 071602
HPD Base # 5703

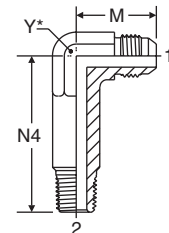

Y* – Across wrench flats

TUBE FITTING PART #	END SIZE		M (in.)	N4 (in.)	Y (in.)	STANDARD Dynamic Pressure (x 1,000 PSI)		
	1 (in.)	2 NPTF				-S	-SS	-B
	4 CCCTX	1/4				1/8-27	0.89	1.56
4-4 CCCTX	1/4	1/4-18	1.05	2.03	9/16	6.0		
5 CCCTX	5/16	1/8-27	0.97	1.63	9/16	6.0		
6 CCCTX	3/8	1/4-18	1.06	2.07	9/16	6.0		3.3
6-6 CCCTX	3/8	3/8-18	1.14	2.34	3/4	6.0		
8 CCCTX	1/2	3/8-18	1.25	2.34	3/4	6.0		
8-8 CCTX	1/2	1/2-14	1.34	2.84	7/8	6.0		
10 CCCTX	5/8	1/2-14	1.45	2.84	7/8	5.0		
12 CCCTX	3/4	3/4-14	1.66	3.22	1 1/16	4.0		
16 CCCTX	1	1-11 1/2	1.81	3.97	1 5/16	3.0		
20 CCCTX	1 1/4	1 1/4-11 1/2	2.06	4.94	1 5/8			

How to Order

Specs

Assembly / Installation

3-D CAD Model

Reference

DTX Full Dimensions

Femle Elbow
37° Flare / NPTF

SAE 070203
HPD Base # 2203

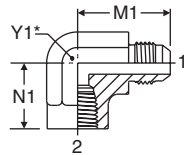

Y* – Across wrench flats

C870MX Full Dimensions

Male Elbow – ISO 6149
37° Flare / ISO 6149

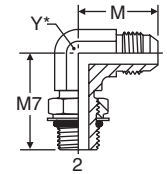

Y* – Across wrench flats

TUBE FITTING PART #	END SIZE		M1 (in.)	N1 (in.)	Y1 (in.)	STANDARD Dynamic Pressure (x 1,000 PSI)		
	1 (in.)	2 NPTF				-S	-SS	-B
	4 DTX	1/4						
4-4 DTX	1/4	1/4-18	1.22	0.88	3/4	5.0	5.0	3.3
5 DTX	5/16	1/8-27	1.08	0.66	9/16	5.0	5.0	3.3
5-4 DTX	5/16	1/4-18	1.13	0.88	3/4	5.0	5.0	3.3
6 DTX	3/8	1/4-18	1.23	0.88	3/4	5.0	5.0	3.3
6-2 DTX	3/8	1/8-27	1.23	0.67	9/16	5.0	5.0	3.3
6-6 DTX	3/8	3/8-18	1.31	1.02	7/8	4.5	4.5	2.9
8 DTX	1/2	3/8-18	1.42	1.02	7/8	4.5	4.5	2.0
8-4 DTX	1/2	1/4-18	1.42	1.01	3/4	4.5	4.5	3.3
8-8 DTX	1/2	1/2-14	1.52	1.23	1 1/16	3.0	3.0	2.0
10 DTX	5/8	1/2-14	1.64	1.23	1 1/16	3.0	3.0	2.0
12 DTX	3/4	3/4-14	1.89	1.36	1 5/16	3.0	3.0	2.0
12-8 DTX	3/4	1/2-14	1.89	1.35	1 1/16	3.0	3.0	2.0
14 DTX	7/8	3/4-14	1.86	1.42	1 5/16	3.0	3.0	2.0
16 DTX	1	1-11 1/2	2.17	1.63	1 5/8	1.8	1.8	1.8
20 DTX	1 1/4	1 1/4-11 1/2	2.33	1.70	1 7/8	1.5	1.5	1.5
24 DTX	1 1/2	1 1/2-11 1/2	2.89	2.08	2 1/2	1.5	1.5	1.5

TUBE FITTING PART #	END SIZE		M (mm)	M7 (mm)	Y (mm)	STANDARD Dynamic Pressure (x 1,000 PSI)		
	1 (mm)	2 Male Metric Parallel Thread				-S	-SS	-B
	4M10C870MX	6						
5M12C870MX	8	M12x1.5	24.1	30.0	13	6.0		
6M14C870MX	10	M14x1.5	26.9	34.9	14	6.0		
8M16C870MX	12	M16x1.5	31.8	35.9	19	5.0		
8M18C870MX	12	M18x1.5	31.8	36.8	19	5.0		
10M18C870MX	14, 15, 16	M18x1.5	36.8	40.7	22	5.0		
10M22C870MX	14, 15, 16	M22x1.5	36.8	41.7	22	5.0		
12M22C870MX	18, 20	M22x.15	42.2	44.4	27	5.0		
12M27C870MX	18, 20	M27x2	42.2	48.5	27	5.0		
16M33C870MX	25	M33x2	46.0	51.2	33	4.0		

C80MX Full Dimensions

Male Elbow – Metric-ORR
37° Flare / Metric-ORR

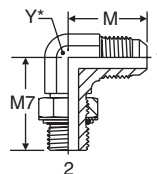

Y* – Across wrench flats

TUBE FITTING PART #	END SIZE		M (mm)	M7 (mm)	Y (mm)	STANDARD Dynamic Pressure (x 1,000 PSI)		
	1 (mm)	2 Male Metric Parallel Thread				-S	-SS	-B
	4M10C80MX	6						
5M12C80MX	8	M12 x 1.5	24.1	28.5	13	3.6		
6M14C80MX	10	M14 x 1.5	26.9	32.5	14	3.6		
8M16C80MX	12	M16 x 1.5	31.8	36.4	19	3.6		
8M18C80MX	12	M18 x 1.5	31.8	36.8	19	3.6		
10M18C80MX	14, 15, 16	M18 x 1.5	36.8	41.0	22	3.6		
10M22C80MX	14, 15, 16	M22 x 1.5	36.8	42.5	22	3.6		
12M22C80MX	18, 20	M22 x .15	42.2	44.0	27	3.6		
12M27C80MX	18, 20	M27 x 2.0	42.2	50.0	27	2.5		
16M33C80MX	25	M33 x 2.0	46.0	53.0	33	2.0		



C40MX Full Dimensions

Male Elbow – BSPP
37° Flare / BSPP-ORR

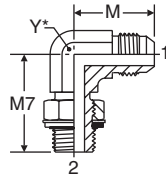

Y* – Across wrench flats

TUBE FITTING PART #	END SIZE		M (mm)	M7 (mm)	Y (mm)	STANDARD Dynamic Pressure (x 1,000 PSI)		
	1 (mm)	2 BSPP				-S	-SS	-B
4C40MX	6	1/8-28	22.6	26.2	11	3.6	3.6	
4-4C40MX	6	1/4-19	22.6	31.8	14	3.6	3.6	
5C40MX	8	1/8-28	24.1	27.7	13	3.6		
5-4C40MX	8	1/4-19	26.6	31.8	14	3.6		
5-6C40MX	8	3/8-19	28.5	36.8	19	3.6		
6C40MX	10	1/4-19	26.9	31.8	14	3.6	3.6	
6-6C40MX	10	3/8-19	29.0	36.8	19	3.6	3.6	
8-4C40MX	12	1/4-19	31.8	36.8	19	3.6		
8C40MX	12	3/8-19	31.8	36.8	19	3.6	3.6	
8-8C40MX	12	1/2-14	33.8	43.2	22	3.6	3.6	
10-6C40MX	16	3/8-19	36.8	37.1	22	3.6		
10C40MX	14,15,16	1/2-14	36.8	43.2	22	3.6	3.6	
10-12C40MX	15	3/4-14	39.2	49.3	27	3.6		
12-8C40MX	18,20	1/2-14	42.2	49.3	27	3.6		
12C40MX	18,20	3/4-14	42.2	49.3	27	3.6	3.6	
12-16C40MX	18	1-11	44.7	52.1	33	3.6		
16-12C40MX	25	3/4-14	46.0	48.2	33	3.6		
16C40MX	25	1-11	46.0	52.1	33	3.6		
20-16C40MX	30,32	1-11	52.3	57.2	41	3.6		
20C40MX	30,32	1 1/4-11	52.3	57.2	41	3.0		
24-20C40MX	38	1 1/4-11	59.2	60.7	48	3.0		
24C40MX	38	1 1/2-11	59.2	60.7	48	2.0		

C3MX Full Dimensions

Male Elbow – BSPT
37° Flare / BSPT

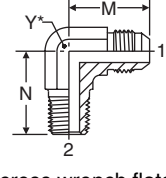

Y* – Across wrench flats

TUBE FITTING PART #	END SIZE		M (mm)	N (mm)	Y (mm)	STANDARD Dynamic Pressure (x 1,000 PSI)		
	1 (mm)	2 BSPT				-S	-SS	-B
4C3MX	6	1/8-28	22.6	19.8	11	4.5		
4-4C3MX	6	1/4-19	26.6	27.7	14	4.5		
5C3MX	8	1/8-28	24.1	19.8	13	4.5		
5-4C3MX	8	1/4-19	26.6	27.7	14	4.5		
6C3MX	10	1/4-19	26.9	27.7	14	4.5		
6-6C3MX	10	3/8-19	29.0	31.0	19	4.5		
6-8C3MX	10	1/2-14	31.0	37.3	22	4.5		
8-4C3MX	12	1/4-19	31.8	31.0	19	4.5		
8C3MX	12	3/8-19	31.8	31.0	19	4.5		
8-8C3MX	12	1/2-14	33.8	37.3	22	4.5		
10-6C3MX	14,15,16	3/8-19	36.5	32.5	22	4.5		
10C3MX	14,15,16	1/2-14	36.8	37.3	22	4.5		
10-12C3MX	14,15,16	3/4-14	39.2	40.4	27	2.3		
12-8C3MX	18,20	1/2-14	42.2	40.4	27	4.5		
12C3MX	18,20	3/4-14	42.2	40.4	27	2.3		
16-12C3MX	25	3/4-14	46.0	45.2	33	2.3		
16C3MX	25	1-11	46.0	50.0	33	2.3		
20-16C3MX	30,32	1-11	52.3	59.7	41	2.3		
20C3MX	30,32	1 1/4-11	52.3	60.5	41	2.3		
24C3MX	38	1 1/2-11	59.2	67.1	48	2.3		

JTX Full Dimensions

Union Tee
37° Flare (all three ends)

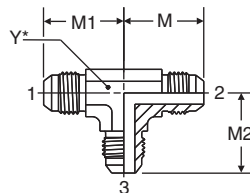

Y* – Across wrench flats

SAE 070401
HPD Base # 033T

TUBE FITTING PART #	END SIZE			M (in.)	M1 (in.)	M2 (in.)	Y (in.)	STANDARD Dynamic Pressure (x 1,000 PSI)		
	1 (in.)	2 (in.)	3 (in.)					-S	-SS	-B
2 JTX	1/8	1/8	1/8	0.78	0.78	0.78	5/16	7.5	7.7	3.3
3 JTX	3/16	3/16	3/16	0.83	0.83	0.83	7/16	7.5	7.7	
4 JTX	1/4	1/4	1/4	0.89	0.89	0.89	7/16	7.5	7.7	3.3
4-4-3 JTX	1/4	1/4	3/16	0.89	0.89	0.81	7/16		7.7	
5 JTX	5/16	5/16	5/16	0.95	0.95	0.95	9/16	6.0	6.0	3.3
6 JTX	3/8	3/8	3/8	1.06	1.06	1.06	9/16	6.0	6.0	3.3
8 JTX	1/2	1/2	1/2	1.25	1.25	1.25	3/4	6.0	6.0	3.3
10 JTX	5/8	5/8	5/8	1.45	1.45	1.45	7/8	5.0	5.0	3.3
12 JTX	3/4	3/4	3/4	1.66	1.66	1.66	1 1/16	5.0	5.0	2.9
12-12-8 JTX	3/4	3/4	1/2	1.66	1.66	1.42	1 1/16		5.0	
12-16-12 JTX	3/4	1	3/4	1.77	1.81	1.77	1 5/16		5.0	
14 JTX	7/8	7/8	7/8	1.73	1.73	1.73	1 5/16	5.0		
16 JTX	1	1	1	1.81	1.81	1.81	1 5/16	4.0	3.5	2.3
20 JTX	1 1/4	1 1/4	1 1/4	2.06	2.06	2.06	1 5/8	4.0	3.0	
24 JTX	1 1/2	1 1/2	1 1/2	2.33	2.33	2.33	1 7/8	3.0	2.0	
24-16-16 JTX	1 1/2	1	1	2.33	2.16	2.16	1 7/8		2.0	
32 JTX	2	2	2	3.06	3.06	3.06	2 1/2	2.0	1.5	



WJTX Full Dimensions

Bulkhead Branch Tee
37° Flare (all three ends)

SAE 070959
HPD Base # 543T
WJTX-WLN – Body with locknut
(See page C10 for WLN)

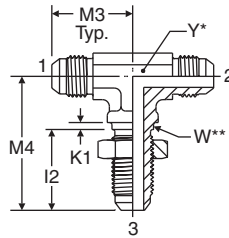

Y* – Across wrench flats.
W** – Bulkhead pilot dia.
recommended clearance hole
+.015 over W dia.

TUBE FITTING PART #	END SIZE	I 2 (in.)	K 1 (in.)	M 3 (in.)	M 4 (in.)	W DIA. (in.)	MAX. BULKHEAD WALL THICKNESS (in.)	Y (in.)	STANDARD Dynamic Pressure (x 1,000 PSI)		
									-S	-SS	-B
4 WJTX	1/4	1.02	0.09	0.97	1.59	0.44	0.21	7/16	7.5	7.7	
6 WJTX	3/8	1.09	0.09	1.09	1.81	0.56	0.28	9/16	6.0	6.0	
8 WJTX	1/2	1.25	0.13	1.36	2.11	0.75	0.33	3/4	6.0	6.0	
10 WJTX	5/8	1.39	0.13	1.56	2.39	0.88	0.32	1 1/16	5.0		
12 WJTX	3/4	1.56	0.13	1.78	2.67	1.06	0.34	1 1/16	5.0	5.0	
16 WJTX*	1	1.56	0.13	1.94	2.80	1.31	0.29	1 5/16	4.0		
20 WJTX*	1 1/4	1.61	0.13	2.17	3.12	1.63	0.29	1 5/8	4.0		

* Machined from one-piece milled bar stock.

WJJTX Full Dimensions

Bulkhead Run Tee
37° Flare (all three ends)

SAE 070958
HPD Base # 533T
WJJTX-WLN – Body with locknut
(See page C10 for WLN)

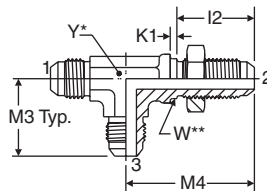

Y* – Across wrench flats.
W** – Bulkhead pilot dia.
recommended clearance hole
+.015 over W dia.

TUBE FITTING PART #	END SIZE	I 2 (in.)	K 1 (in.)	M 3 (in.)	M 4 (in.)	W DIA. (in.)	MAX. BULKHEAD WALL THICKNESS (in.)	Y (in.)	STANDARD Dynamic Pressure (x 1,000 PSI)		
									-S	-SS	-B
4 WJJTX	1/4	1.02	0.09	0.97	1.59	0.44	0.21	7/16	7.5	7.7	
6 WJJTX	3/8	1.09	0.09	1.09	1.81	0.56	0.28	9/16	6.0	6.0	
8 WJJTX	1/2	1.25	0.13	1.36	2.11	0.75	0.33	3/4	6.0	6.0	
10 WJJTX	5/8	1.39	0.13	1.56	2.39	0.88	0.32	7/8	5.0		
12 WJJTX	3/4	1.56	0.13	1.78	2.67	1.06	0.34	1 1/16	5.0	5.0	
16 WJJTX*	1	1.56	0.13	1.94	2.80	1.31	0.29	1 7/16	4.0		
20 WJJTX*	1 1/4	1.61	0.13	2.17	3.12	1.63	0.29	1 5/8	4.0		



JX6 Full Dimensions

Swivel Nut Union Tee
37° Swivel (all three ends)

HPD Base # 069T

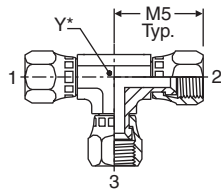

Y* – Across wrench flats

TUBE FITTING PART #	END SIZE (in.)	M5 (in.)	Y (in.)	STANDARD Dynamic Pressure (x 1,000 PSI)		
				-S	-SS	-B
4 JX6	1/4	1.00	7/16	7.5		
6 JX6	3/8	1.25	9/16	5.0		
8 JX6	1/2	1.38	3/4	5.0		
10 JX6	5/8	1.62	7/8	5.0		
12 JX6	3/4	1.75	1 1/16	5.0		
16 JX6	1	2.00	1 3/16	3.6		

S6X Full Dimensions

Swivel Nut Branch Tee
37° Flare / 37° Flare / 37° Swivel

SAE 070433
HPD Base # 393T

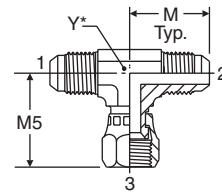

Y* – Across wrench flats

TUBE FITTING PART #	END SIZE (in.)	M (in.)	M5 (in.)	Y (in.)	STANDARD Dynamic Pressure (x 1,000 PSI)		
					-S	-SS	-B
4 S6X	1/4	0.89	1.00	7/16	7.5	7.7	
5 S6X	5/16	0.95	1.16	9/16	6.0	6.0	
6 S6X	3/8	1.06	1.25	9/16	5.0	6.0	
8 S6X	1/2	1.25	1.38	3/4	5.0	6.0	
10 S6X	5/8	1.45	1.62	7/8	5.0	5.0	
12 S6X	3/4	1.66	1.75	1 1/16	5.0	5.0	
14 S6X	7/8	1.80	1.78	1 5/16	4.0		
16 S6X	1	1.81	2.00	1 5/16	3.6	2.5	
20 S6X	1 1/4	2.06	2.31	1 5/8	3.6	2.5	
24 S6X	1 1/2	2.33	2.67	1 7/8	2.5	2.0	

R6X Full Dimensions

Swivel Nut Run Tee
37° Flare / 37° Swivel / 37° Flare

SAE 070432
HPD Base # 063T

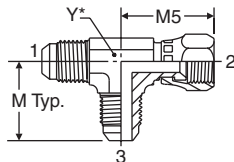

Y* – Across wrench flats

TUBE FITTING PART #	END SIZE (in.)	M (in.)	M5 (in.)	Y (in.)	STANDARD Dynamic Pressure (x 1,000 PSI)		
					-S	-SS	-B
4 R6X	1/4	0.89	1.00	7/16	7.5	7.7	
5 R6X	5/16	0.95	1.06	9/16	6.0	6.0	
6 R6X	3/8	1.06	1.25	9/16	5.0	6.0	
8 R6X	1/2	1.25	1.38	3/4	5.0	6.0	
10 R6X	5/8	1.45	1.62	7/8	5.0	5.0	
12 R6X	3/4	1.66	1.75	1 1/16	5.0	5.0	
14 R6X	7/8	1.80	1.78	1 5/16	4.0		
16 R6X	1	1.81	2.00	1 5/16	3.6	2.5	
20 R6X	1 1/4	2.06	2.31	1 5/8	3.6	2.5	
24 R6X	1 1/2	2.33	2.59	1 7/8	2.5	2.0	



S50X

Full Dimensions

Straight Thread Branch Tee
37° Flare / 37° Flare /
SAE-ORB

SAE 070429
HPD Base # 253T

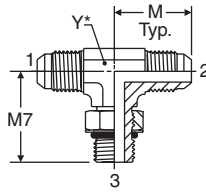

Y* – Across wrench flats

TUBE FITTING PART #	END SIZE			M (in.)	M7 (in.)	Y (in.)	STANDARD Dynamic Pressure (x 1,000 PSI)		
	1 (in.)	2 (in.)	3 UN/UNF-2A				-S	-SS	-B
4 S50X	1/4	1/4	7/16-20	0.89	1.03	7/16	6.0	6.0	
4-4-6 S50X	1/4	1/4	9/16-18	1.05	1.25	9/16	6.0		
5 S50X	5/16	5/16	1/2-20	0.97	1.13	9/16	6.0		
6 S50X	3/8	3/8	9/16-18	1.06	1.25	9/16	6.0	5.4	
6-6-8 S50X	3/8	3/8	3/4-16	1.14	1.45	3/4	6.0		
8 S50X	1/2	1/2	3/4-16	1.25	1.45	3/4	6.0	5.4	
8-8-10 S50X	1/2	1/2	7/8-14	1.33	1.70	7/8	5.0		
10 S50X	5/8	5/8	7/8-14	1.45	1.70	7/8	5.0	5.4	
10-10-12 S50X	5/8	5/8	1 1/16-12	1.54	1.94	1 1/16	5.0		
12 S50X	3/4	3/4	1 1/16-12	1.66	1.94	1 1/16	5.0	5.4	
12-12-16 S50X	3/4	3/4	1 5/16-12	1.77	2.05	1 5/16	4.0		
16 S50X	1	1	1 5/16-12	1.81	2.05	1 5/16	4.0	3.0	
20 S50X	1 1/4	1 1/4	1 5/8-12	2.06	2.25	1 5/8	4.0	2.5	
24 S50X	1 1/2	1 1/2	1 7/8-12	2.33	2.39	1 7/8	3.0		
32 S50X	2	2	2 1/2-12	3.06	2.89	2.50	2.0		

R50X

Full Dimensions

Straight Thread Run Tee
37° Flare / SAE-ORB /
37° Flare

SAE 070428
HPD Base # 053T

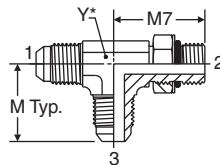

Y* – Across wrench flats

TUBE FITTING PART #	END SIZE			M (in.)	M7 (in.)	Y (in.)	STANDARD Dynamic Pressure (x 1,000 PSI)		
	1 (in.)	2 UN/UNF-2A	3 (in.)				-S	-SS	-B
4 R50X	1/4	7/16-20	1/4	0.89	1.03	7/16	6.0	6.0	
4-6-4 R50X	1/4	9/16-18	1/4	1.00	1.25	9/16	6.0		
5 R50X	5/16	1/2-20	5/16	0.97	1.13	9/16	6.0		
6 R50X	3/8	9/16-18	3/8	1.06	1.25	9/16	6.0	5.4	
6-8-6 R50X	3/8	3/4-16	3/8	1.14	1.45	3/4	6.0		
8 R50X	1/2	3/4-16	1/2	1.25	1.45	3/4	6.0	5.4	
8-10-8 R50X	1/2	7/8-14	1/2	1.33	1.70	7/8	5.0		
10 R50X	5/8	7/8-14	5/8	1.45	1.70	7/8	5.0	5.4	
10-12-10 R50X	5/8	1 1/16-12	5/8	1.53	1.94	1 1/16	5.0		
12 R50X	3/4	1 1/16-12	3/4	1.66	1.94	1 1/16	5.0	5.4	
12-16-12 R50X	3/4	1 5/16-12	3/4	1.76	2.05	1 5/16	4.0		
16 R50X	1	1 5/16-12	1	1.81	2.05	1 5/16	4.0	3.0	
20 R50X	1 1/4	1 5/8-12	1 1/4	2.06	2.25	1 5/8	4.0	2.5	
24 R50X	1 1/2	1 7/8-12	1 1/2	2.33	2.39	1 7/8	3.0		
32 R50X	2	2 1/2-12	2	3.06	2.89	2 1/2	2.0		



STX Full Dimensions

Male Branch Tee
37° Flare / 37° Flare / NPTF

SAE 070425
HPD Base # 213T

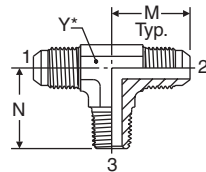

Y* – Across wrench flats

TUBE FITTING PART #	END SIZE		M (in.)	N (in.)	Y (in.)	STANDARD Dynamic Pressure (x 1,000 PSI)		
	1 & 2 (in.)	3 NPTF				-S	-SS	-B
	3 STX	3/16						
4 STX	1/4	1/8-27	0.89	0.78	7/16	6.0	6.0	3.3
4-4-4 STX	1/4	1/4-18	1.05	1.09	9/16	6.0	6.0	3.3
4-4-6 STX	1/4	3/8-18	1.13	1.22	3/4		6.0	
5 STX	5/16	1/8-27	0.95	0.78	9/16	6.0	6.0	3.3
5-5-4 STX	5/16	1/4-18	1.05	1.09	9/16		6.0	
6 STX	3/8	1/4-18	1.06	1.09	9/16	6.0	6.0	3.3
6-6-6 STX	3/8	3/8-18	1.14	1.22	3/4	6.0	6.0	
8 STX	1/2	3/8-18	1.25	1.22	3/4	6.0	6.0	3.3
8-8-8 STX	1/2	1/2-14	1.34	1.47	7/8	6.0	6.0	
10 STX	5/8	1/2-14	1.45	1.47	7/8	5.0	5.0	3.3
12 STX	3/4	3/4-14	1.66	1.59	1 1/16	4.0	4.0	
14 STX	7/8	3/4-14	1.80	1.69	1 5/16	4.0		
16 STX	1	1-11 1/2	1.81	1.97	1 5/16	3.0	3.0	
20 STX	1 1/4	1 1/4-11 1/2	2.06	2.38	1 5/8	2.5	2.5	
24 STX	1 1/2	1 1/2-11 1/2	1.33	2.64	1 7/8	2.5	2.5	

RTX Full Dimensions

Male Run Tee
37° Flare / NPTF / 37° Flare

SAE 070424
HPD Base # 013T

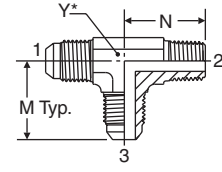

Y* – Across wrench flats

TUBE FITTING PART #	END SIZE		M (in.)	N (in.)	Y (in.)	STANDARD Dynamic Pressure (x 1,000 PSI)		
	1 & 3 (in.)	2 NPTF				-S	-SS	-B
	3 RTX	3/16						
4 RTX	1/4	1/8-27	0.89	0.78	7/16	6.0	6.0	3.3
4-4-4 RTX	1/4	1/4-18	1.05	1.09	9/16	6.0	6.0	
5 RTX	5/16	1/8-27	0.97	0.81	9/16	6.0	6.0	3.3
5-4-5 RTX	5/16	1/4-18	1.05	1.09	9/16		6.0	
6 RTX	3/8	1/4-18	1.06	1.09	9/16	6.0	6.0	3.3
6-6-6 RTX	3/8	3/8-18	1.14	1.22	3/4	6.0	6.0	
8 RTX	1/2	3/8-18	1.25	1.22	3/4	6.0	6.0	3.3
8-8-8 RTX	1/2	1/2-14	1.34	1.47	7/8	6.0	6.0	
10 RTX	5/8	1/2-14	1.45	1.47	7/8	5.0	5.0	
12 RTX	3/4	3/4-14	1.66	1.59	1 1/16	4.0	4.0	
12-8-12 RTX	3/4	1/2-14	1.66	1.59	1 1/16		5.0	
14 RTX	7/8	3/4-14	1.80	1.69	1 5/16	4.0		
16 RTX	1	1-11 1/2	1.81	1.97	1 5/16	3.0	3.0	
20 RTX	1 1/4	1 1/4-11 1/2	2.06	2.38	1 5/8	2.5	2.5	
24 RTX	1 1/2	1 1/2-11 1/2	2.33	2.64	1 7/8	2.5	2.5	

OTX Full Dimensions

Female Branch Tee
37° Flare / 37° Flare / NPTF

SAE 070427
HPD Base # 223T

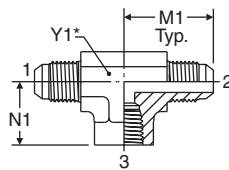

Y1* – Across wrench flats

TUBE FITTING PART #	END SIZE		M1 (in.)	N1 (in.)	Y1 (in.)	STANDARD Dynamic Pressure (x 1,000 PSI)		
	1 & 2 (in.)	3 NPTF				-S	-SS	-B
	4 OTX	1/4						
4-4-4 OTX	1/4	1/4-18	1.13	0.88	3/4		5.0	
5 OTX	5/16	1/8-27	1.08	0.66	9/16	5.0		
6 OTX	3/8	1/4-18	1.24	0.88	3/4	5.0	5.0	3.3
6-6-6 OTX	3/8	3/8-18	1.23	1.02	7/8	4.5	4.5	
8 OTX	1/2	3/8-18	1.42	1.02	7/8	4.5	4.5	2.9
8-8-8 OTX	1/2	1/2-14	1.42	1.23	1 1/16	3.0	3.0	
10 OTX	5/8	1/2-14	1.64	1.24	1 1/16	3.0	3.0	
12 OTX	3/4	3/4-14	1.89	1.36	1 5/16	3.0	3.0	2.0
14 OTX	7/8	3/4-14	1.86	1.42	1 5/16	3.0		
16 OTX	1	1-11 1/2	2.17	1.63	1 5/8	1.8		
20 OTX	1 1/4	1 1/4-11 1/2	2.33	1.70	1 7/8	1.5		
24 OTX	1 1/2	1 1/2-11 1/2	2.89	2.08	2 1/2	1.5		

MTX Full Dimensions

Female Run Tee
37° Flare / NPTF / 37° Flare

SAE 070426
HPD Base # 023T

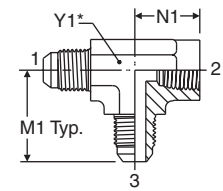

Y1* – Across wrench flats

TUBE FITTING PART #	END SIZE		M1 (in.)	N1 (in.)	Y1 (in.)	STANDARD Dynamic Pressure (x 1,000 PSI)		
	1 & 3 (in.)	2 NPTF				-S	-SS	-B
	4 MTX	1/4						
4-4-4 MTX	1/4	1/4-18	1.13	0.88	3/4		5.0	
6 MTX	3/8	1/4-18	1.24	0.88	3/4	5.0	5.0	3.3
8 MTX	1/2	3/8-18	1.42	1.02	7/8	4.5	4.5	2.9
8-8-8 MTX	1/2	1/2-14	1.42	1.23	1 1/16	3.0	3.0	
10 MTX	5/8	1/2-14	1.64	1.24	1 1/16	3.0	3.0	
12 MTX	3/4	3/4-14	1.89	1.36	1 5/16	3.0	3.0	
14 MTX	7/8	3/4-14	1.86	1.42	1 5/16	3.0		
16 MTX	1	1-11 1/2	2.17	1.63	1 5/8	1.8		
20 MTX	1 1/4	1 1/4-11 1/2	2.33	1.70	1 7/8	1.5		
24 MTX	1 1/2	1 1/2-11 1/2	2.89	2.08	2 1/2			

How to Order

Specs

Assembly / Installation

3-D CAD Model

Reference

S870MX Full Dimensions

ISO 6149 Branch Tee
37° Flare / 37° Flare / ISO 6149

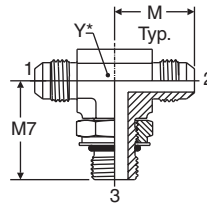

Y* – Across wrench flats

TUBE FITTING PART #	END SIZE		M (mm)	M7 (mm)	Y (mm)	STANDARD Dynamic Pressure (x 1,000 PSI)		
	1 & 2 (mm)	3 Male Metric Parallel Thread				-S	-SS	-B
	6M14S870MX	10						
8M16S870MX	12	M16x1.5	31.8	38.0	19	5.0		
10M22S870MX	14, 15, 16	M22x1.5	36.8	42.5	22	5.0		
12M27S870MX	18, 20	M27x1.5	42.2	51.0	27	5.0		

R870MX Full Dimensions

ISO 6149 Run Tee
37° Flare / ISO 6149 / 37° Flare

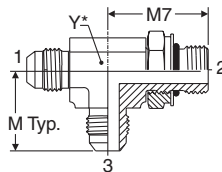

Y* – Across wrench flats

TUBE FITTING PART #	END SIZE		M (mm)	M7 (mm)	Y (mm)	STANDARD Dynamic Pressure (x 1,000 PSI)		
	1 & 3 (mm)	2 Male Metric Parallel Thread				-S	-SS	-B
	6M14R870MX	10						
8M16R870MX	12	M16x1.5	31.8	38.0	19	5.0		
10M22R870MX	14, 15, 16	M22x1.5	36.8	42.5	22	5.0		
12M27R870MX	18, 20	M27x1.5	42.2	51.0	27	5.0		

S40MX Full Dimensions

Male Branch Tee – BSPP
37° Flare / 37° Flare / BSPP-ORR

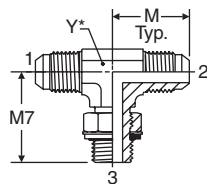

Y* – Across wrench flats

TUBE FITTING PART #	END SIZE		M (mm)	M7 (mm)	Y (mm)	STANDARD Dynamic Pressure (x 1,000 PSI)		
	1 & 2 (mm)	3 BSPP				-S	-SS	-B
	4S40MX	6						
6S40MX	10	1/4-19	26.9	31.8	14	3.6		
8S40MX	12	3/8-19	31.8	36.8	19	3.6		
10S40MX	14,15,16	1/2-14	36.8	43.2	22	3.6		
12S40MX	18,20	3/4-14	42.2	49.3	27	3.6		
16S40MX	25	1-11	46.0	52.1	33	3.6		
20S40MX	28, 30, 32	1 1/4-11	52.3	57.2	41			

R40MX Full Dimensions

Male Run Tee – BSPP
37° Flare / BSPP-ORR / 37° Flare

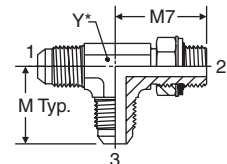

Y* – Across wrench flats

TUBE FITTING PART #	END SIZE		M (mm)	M7 (mm)	Y (mm)	STANDARD Dynamic Pressure (x 1,000 PSI)		
	1 & 3 (mm)	2 BSPP				-S	-SS	-B
	4R40MX	6						
6R40MX	10	1/4-19	26.9	31.8	14	3.6		
8R40MX	12	3/8-19	31.8	36.8	19	3.6		
10R40MX	14,15,16	1/2-14	36.8	43.2	22	3.6		
12R40MX	18,20	3/4-14	42.2	49.3	27	3.6		
16R40MX	25	1-11	46.0	52.1	33	3.6		
20R40MX	28, 30, 32	1 1/4-11	52.3	57.2	41	3.0		



KTX Full Dimensions

Union Cross
37° Flare (all four ends)

SAE 070501
HPD Base # 033X

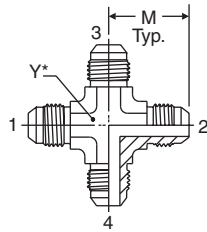

Y* – Across wrench flats

TUBE FITTING PART #	END SIZE (in.)	M (in.)	Y (in.)	STANDARD Dynamic Pressure (x 1,000 PSI)		
				-S	-SS	-B
4 KTX	1/4	0.89	7/16	7.5	7.7	3.3
5 KTX	5/16	0.95	9/16	6.0		
6 KTX	3/8	1.06	9/16	6.0	6.0	3.3
8 KTX	1/2	1.25	3/4	6.0	6.0	3.3
10 KTX	5/8	1.45	7/8	5.0		
12 KTX	3/4	1.66	1 1/16	5.0	5.0	
16 KTX	1	1.81	1 5/16	4.0		

PNTX Full Dimensions

Plug
37° Flare

SAE 070109
HPD Base # 03CP

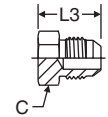

TUBE FITTING PART #	END SIZE (in.)	C HEX (in.)	L3 (in.)	STANDARD Dynamic Pressure (x 1,000 PSI)		
				-S	-SS	-B
2 PNTX	1/8	7/16	0.70		9.0	
3 PNTX	3/16	7/16	0.73	7.5	9.0	
4 PNTX	1/4	1/2	0.80	7.5	9.0	3.3
5 PNTX	5/16	9/16	0.80	6.0	7.2	3.3
6 PNTX	3/8	5/8	0.84	6.0	7.2	3.3
8 PNTX	1/2	13/16	0.94	6.0	7.2	3.3
10 PNTX	5/8	15/16	1.10	5.0	6.0	3.3
12 PNTX	3/4	1 1/8	1.28	5.0	6.0	3.3
14 PNTX	7/8	1 1/4	1.31	5.0		
16 PNTX	1	1 3/8	1.33	4.5	5.4	2.6
20 PNTX	1 1/4	1 11/16	1.45	4.0	4.8	
24 PNTX	1 1/2	2	1.66	4.0	4.8	
32 PNTX	2	2 5/8	2.05	2.0	2.4	

FNTX Full Dimensions

Cap
37° Flare

SAE 070112
HPD Base # 06CP

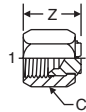

TUBE FITTING PART #	END SIZE (in.)	C HEX (in.)	Z (in.)	STANDARD Dynamic Pressure (x 1,000 PSI)		
				-S	-SS	-B
2 FNTX	1/8	3/8	0.60	7.5	9.0	3.3
3 FNTX	3/16	7/16	0.66	7.5	9.0	3.3
4 FNTX	1/4	9/16	0.67	7.5	9.0	3.3
5 FNTX	5/16	5/8	0.77	6.0	7.2	3.3
6 FNTX	3/8	11/16	0.81	6.0	7.2	3.3
8 FNTX	1/2	7/8	0.94	6.0	7.2	3.3
10 FNTX	5/8	1	1.07	5.0	6.0	3.3
12 FNTX	3/4	1 1/4	1.24	5.0	6.0	3.3
14 FNTX	7/8	1 3/8	1.26	5.0		
16 FNTX	1	1 1/2	1.29	4.5	5.4	2.6
20 FNTX	1 1/4	2	1.39	4.0	4.8	
24 FNTX	1 1/2	2 1/4	1.70	4.0	4.8	
32 FNTX	2	2 7/8	2.01	2.0	2.4	

T22X Full Dimensions

Mountie Cap

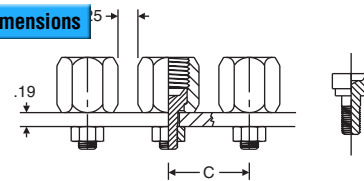

TUBE FITTING PART #	END SIZE		C (in.)	L (in.)	STANDARD Dynamic Pressure (x 1,000 PSI)		
	1 (in.)	2 UN/UNF-2B			-S	-SS	-B
4 T22X	1/4	1/4-20	0.91	0.72	7.5		
6 T22X	3/8	1/4-20	1.08	0.81	6.0		
8 T22X	1/2	5/16-18	1.25	0.97	6.0		

